

**Golfkontor**  
All you need!

2018 | PRODUCT  
BROCHURE



**cligear**



**BagBoy**



**BETTINARDI**



**Shot Scope**



**Longridge**

# EXPERIENCE THE MOST COMPLETE SELECTION OF GOLF PRODUCTS

JS International brings you from Cutting-Edge push carts to premium insulated

the best Golf has to offer to the World's Smartest Watch Water Bottles and more!

## INNOVATIVE

Supplying the most up to date technology for the golfer.

## PROFIT & QUALITY

Huge range of top selling right choice products with great margins.

## EXCLUSIVE

We offer many quality brands exclusively within Europe.

## PROFESSIONAL

With 24 years in the Golf industry, we have a dedicated team to help grow your business.



voice caddy



CLUB WHEELS BOOSTER



clicgear



BETTINARDI



Shot Scope



ECOVESSEL



ENERTOR  
POWERED BY D3O



COLIN MONTGOMERIE



Longridge



EZEGLIDE

# 2018 CONTENTS

<b>EWHEELS</b>	<b>6</b>	<b>CLUBS &amp; PACKAGES</b>	<b>67</b>	<b>ST ANDREWS LINKS</b>	<b>122</b>
Club Booster Ewheels	6	Spalding True Black Set	67	Golf Towel	122
<b>CLICGEAR</b>	<b>8</b>	VL4 package	68	Hats	122
Clicgear 3.5+	8	Vector package	69	Gift Sets	123
Clicgear 8	10	Challenger Kids sets	71	Notebook	124
Clicgear B3	11	Tiger Plus kids set	72	Fob Key ring	124
Clicgear 6	12	Junior accessories	73	Mugs	125
Clicgear Accessories	12	Wedges, Chippers & Putter	74		
		Junior putter	75		
<b>ROVIC</b>	<b>16</b>	<b>HEADCOVERS &amp; GLOVES</b>	<b>76</b>	<b>GIFT &amp; NOVELTY</b>	<b>126</b>
RV1S swivel	16	Magnetix Headcovers	76	Golf Gifts	126
RV1C compact	17	Iron & Wood Headcovers	77	Novelty Golf Balls	128
Rovic RV2L lite weight	18	Novelty Headcovers	79	Multi Tool	130
Rovic RV3J junior	19	Gloves	80	Ball Display	130
Accessories	19	Accessories, Handwarmers	81	Trophies	131
<b>BAGBOY</b>	<b>20</b>	<b>ELECTRONIC AIDS</b>	<b>82</b>	<b>BALLS, TEES &amp; SPIKES</b>	<b>132</b>
Compact 3	21	Shot Scope V2	82	Spalding Balls	132
TriSwivel II	22	Voice Caddie Lanch monitor	84	Range Balls	132
Quad XL	23	Laser Distance Finder	86	Lake Balls	133
C-302 cart bag	24	Scoreband	87	Tees	134
Revolver FX cart bag	25			Champ Tees	136
Lite Rider II cart bag	26			Champ Spikes	138
C-500 cart bag	27			Shoes Bag & Accessories	140
S-259 stand bag	28				
Stand bag	29				
Carry Lite Pro stand bag	30	<b>PRACTICE AIDS</b>	<b>88</b>	<b>ENERTOR</b>	<b>142</b>
Trekker stand bag	31	Practice Nets	88	Performance Insoles	143
Travel cover	32	Practice Mats	92	Comfort Insoles	143
Riksha R-3000 rental trolley	34	Welling Putt Mats	94	Floor Stand POS	143
Accessories	35	Training Aids	97		
		Practice Balls	98		
		Alignment Sticks	101		
<b>BETTINARDI</b>	<b>38</b>	<b>GOLF ACCESSORIES</b>	<b>102</b>	<b>GRIPS &amp; WORKSHOP</b>	<b>144</b>
BB Series	40	Ball Retrievers	102	Golf Pride Grips	144
iNovai 5.0 Series	43	Medicus Training Clubs	104	Winn Grips	149
Studio Stock Series	44	Accessories	105	SuperStroke Grips	150
Queen B Series	47	Scorecards	106	Pure Grips	153
H2 303 SS Wedges	48	Brush & cleaners	107	Lamkin Grips	157
Accessories	50	Pitchforks	108	Longridge Grips`	159
Staff Cart Bag	51	Ballmarkers	109	Two Thumbs Grips	159
		Golf Towels	110	Point of Sale	160
		Umbrellas	112	Golf Workshop	162
<b>TROLLEY &amp; ACCESSORIES</b>	<b>52</b>	<b>ECO VESSEL</b>	<b>113</b>	<b>CUSTOM LOGOS</b>	<b>163</b>
Fast Fold Flat fold trolley	52	The Metro	113	Pithforks	164
EzeGlide trolleys	52	The Boulder	114	Ball Markers	165
Longridge trolleys	55	Boss Glowler	115	Tees	166
Accessories	57	Double Barrel	115	Ball & Accessories	166
Edgehog Winter wheels	59	The Vine	115	Towels	167
		The Port	116	Shoes & Accessories Bag	168
		The Aspen	116	Golf Bags	169
				Umbrellas	170
				Gloves	170
				EcoVassel	171
<b>BAGS &amp; COVERS</b>	<b>60</b>	<b>COLIN MONTGOMERIE</b>	<b>117</b>		
Longridge Aqua cart bag	60	Executive Putting Set	117		
Longridge Pro cart bag	61	Digital Scorers	117		
Longridge Executive cart bag	61	Gift Sets	118		
Longridge Stand bag/golf bag	62	Pen Sets	118		
Longridge Travel cover	63	Accessories Sets	119		
Longridge Rain covers	65	Practice Aids	120		

# CLUB eWheels BOOSTER™

TURN YOUR PUSH CART INTO A REMOTE ELECTRIC TROLLEY!

New 2018



● TREWS Black

by **ALPHARD**

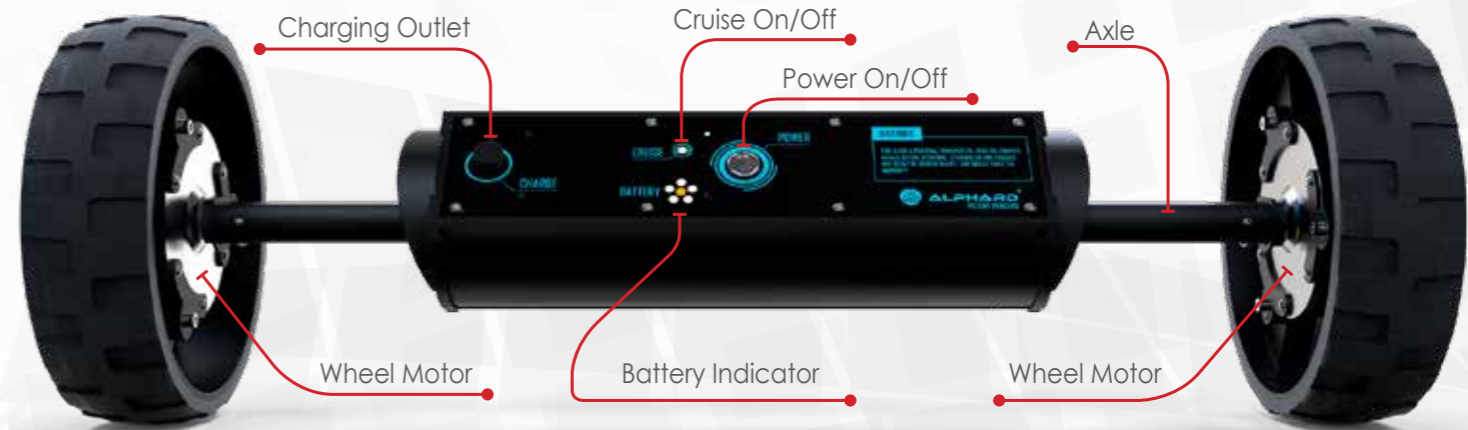

## Remote Control



Magnetic Remote Holder (Included)

## E-Wheel Bracket Set

● One Bracket included with E-wheel, can be chosen from the list below



## Supported Brands/Models

Model	Code
Clicgear 3.5	TREWABS00
Clicgear 8.0	TREWABS01
Rovic (All models)	TREWABS02
SUN MTN Speed Cart / Big Max IQ	TREWABS03
SUN MTN Micro Cart	TREWABS04
BagBoy Quad XL	TREWABS05
BagBoy Tri-Swivel II	TREWABS06
Ezeglise Smartfold	TREWABS07
Other Brands under development	

## Spare part

Part	Code
Battery	TREWABAT
Motor	TREWAMOT
Circuit Board	TREWACB

## WHAT IS CLUB BOOSTER EWHEELS?

The world's first ever powered wheels that converts your pushcart into a remote-controlled motorised electric golf trolley.



- ⊗ Long Lasting Lithium Battery
- ⊗ Fits Most Push Carts
- ⊗ Easy to install
- ⊗ Remote Controlled
- ⊗ Cruise Control
- ⊗ Distance presets
- ⊗ Smooth Steering
- ⊗ Tight turning circle

Warranty covers the unit, battery and charger of any manufacturing defects that occur during normal usage. Warranty is subject, but not limited to, the following exclusions:

- Accidental damage, consumer misuse, abuse or neglect
- Abnormal wear and tear
- Rental or commercial use
- Unauthorised modification to the product
- Faulty repairs by consumer or unauthorised agent
- Usage of an unauthorised 3rd party charger
- Removal of, or defacing serial numbers



## Storage Bag TREWATB

● Protective travel cover keeps your Club Booster safe and sturdy and protects your rig from dirt and debris from the course.



## Belt Clip TREWABC

● High quality, convenient Belt clip for easy access and protection of your remote. Swivels 360 degrees for vertical or horizontal orientation. Great for protective storage in Golf bag.



## Car Charger TREWACC



## Ewheel Omni Trolley Frame TREWAOML

● Specifically designed trolley frame for ewheels. Include 360 front swivel wheel.



## Anti Tip Rear Stabilizer Wheel TREWABW

● Under development

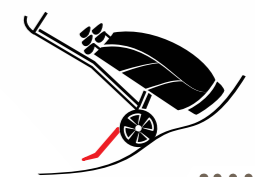



**cligear**

- Easy lift brake lever.
- Extra deep console.
- Mesh pocket for extra storage.
- Push button release for front wheel lock.
- 4 x Tabs on console for easy mounting of accessories.
- Drinks & Umbrella holders included.
- Aircraft grade aluminium lightweight frame.
- Wheels with posi-lock brakes.
- Super compact folding design.
- High quality construction making the trolley extremely durable.
- Folded dimensions: 38 x 33 x 60cm.

**MODEL**  
**3.5+**



TRCC35WH  
White

TRCC35AWPK  
White/Pink

TRCC35BL  
Blue



TRCC35CLI  
Charcoal/Lime

TRCC35COR  
Charcoal/Orange

TRCC35OR  
Orange



TRCC35SI  
Silver

TRCC35CH  
Charcoal

TRCC35BK  
Black



**cligear**

**MODEL**



- Patented 4 X FOLD™ folding system.
- Easy V-Slide to close system.
- Patented frame design.
- Patented foot guard for easy closing.
- Adjustable tracking.
- Dual front brakes and Ultralight airless wheels.
- Drinks holder & Umbrella holder included.
- Large console with magnetic closure and room for accessories.
- Large storage net.
- 10" Front wheel, 12" Rear wheel.
- Folded dimensions: 38 x 68 x 43cm.



○ TRCC8WH  
White



● TRCC8BL  
Blue



● TRCC8SRD  
Silver/Red



● TRCC8CGY  
Charcoal

**cligear**

**Cart Bag**



- 14 way divider.
- Size: 12" top diameter.
- Full Length club dividers.
- No twist rubber saddle strap.
- First aid & waterproof pouch.
- Top quality materials and design.
- Rubber foot cart base.
- Extra large ball pocket.
- 13 pockets in total.
- Lay flat upper flex handle.
- Large cooler compartment.
- Gloves velcro (x2).
- Pen holders (x2).

**14  
WAY**



- BACBB3BK Black
- BACBB3OR Orange
- BACBB3SI Silver
- BACBB3BL Blue
- BACBB3LI Lime

**cliggear**

**Premium Rental Trolley**

- Full feature console.
- Scratch resistant powder coated tubing.
- Removable handle to prevent theft.
- Oversize tubing.
- Adjustable bracket height.
- Drinks holder.
- Umbrella holder.
- Massive 17" airless wheels.
- Custom Program: Ask for more details.
- Customised Console.
- Custom Logo Size: 180 x 75mm.

**MODEL 6**



TRCC6SI Silver

TRCC6CH Charcoal

**Cliggear Model 3.5+ Accessories**

**Storage Bag**  
TRCCASTB



**Wheel Cover**  
TRCCWC



**Cooler Bag**  
TRCCACB



**Attachable Seat**  
TRCCASEAT



**Model 3.5+ Shoe Brush**  
TRCCABR



**Upper Saddle Extender**  
TRCCAUSE



Increase height the upper Bag bracket about 8cm

**Cliggear Model 8 Accessories**

**Storage Bag**  
TRCC8ATC



**Wheel Covers**  
TRCC8AWC



**Accessory Bag**  
TRCC8AB



**3pk Wheel Kit**



**Booster Clip**  
TRCCABC BOOSTERS



Adds extra Height for standbags

**3pk Hedgehog Sleeves**  
TRCCAHW



Fits Model 3.5+

**Cooler Bag**  
TRCC8ACB



**4pk Hedgehog Wheels**  
TRCCAHW8



Hedgehog wheels Replace standard Model 8 wheels

Only fits Model 8

**Cart Seat**  
TRCC8ASEAT



**Shoe Brush**  
TRCC8ASB



**Tour Bag Bottom Support**  
TRCCATBBS



Hedgehog wheels will not work with 3.5 Trolley unless bottom bag support is changed to the Tour Bag Bottom Support.

**Tour Bag Kit**  
TRCCATBB



Kit includes top and bottom bracket bag supports. This allows larger tour style golf bags with larger front pockets to fit on Cliggear Trolleys.

**Storage Hook**  
TRCCASH



**Universal Clicgear Accessories**

Fits all Clicgear & Rovic models

**Wheeled Travel Cover**  
TRCCAWTC

New 2018

Fits  
Clicgear 3.5+  
Rovic RV1C  
Rovic RV1S



**Mesh Storage Net**  
TRCCAMSN

New 2018



**Accessory Bag**  
TRCCAB



**Drinks Holder Plus**

TRCCABHP  
Standard  
TRCCABHXL  
XLarge



**Towel**

TRCCACAGT3B



**Club Brush**  
TRCCACLB



**Cooler Tube**  
TRCCCB



**Bag Cozy**  
TRCCABCOZ



Secures standbags to  
Clicgear and Rovic  
trolleys. Can fit most  
brands of trolleys.

**Ball Holder Clip**  
TRCCABCBK



**Sand Bottle**  
TRCCASB



**Accessory Dock**  
TRCCAAT



The Clicgear accessory dock is available to buy individually, this allows you to fit Clicgear Clic-On accessories on other golf trolleys.

**Cigarette & Cigar Holder**  
TRCCACH



**Bag Shaft**  
TRCCASACP

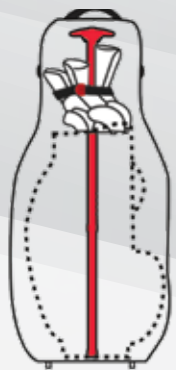

**Trolley Mittens**  
TRWCCWM



\* Suitable for  
EzeGlide &  
Sun  
Mountain

**Steering Knob**  
TRCCASK



**Umbrella Holder**  
TRCCUH



**Deluxe Umbrella Holder**  
TRCCUHD



Adjustable

**Umbrella Spacer**  
TRCCAUHS



Adds extra  
height for  
accessories

**iPhone Rubberised Case**  
TRCCAPC4  
iPhone 4



**GPS Holder**  
TRCCAGPS



**GPS Watch Mount**  
TRCCAGPSW



**Clicgear Umbrella**

- TRCCUMWPSI Silver
- TRCCUMWPBK Black
- TRCCUMWPBR Black/Red



**Rain Cover**



New 2018

- TRCCARC Red
- TRCCARCB Black



rovic

# RV1S SWIVEL

- 360° swivel front wheel.
- Swivel wheel lock.
- Stylish multi-feature console.
- Built-in accessory storage.
- Quick push button folding system.
- Lightweight aluminium frame.
- Compact folding system.
- Soft grip handle.
- Drinks holder & Umbrella holder included.
- Foot brake.
- 2 x Accessory tabs.
- Folded dimensions: 33 x 38 x 60cm.



**TRRV1SWALI**  
Arctic/Lime



**TRRV1SWSBK**  
Silver/Black



**TRRV1SWCBK**  
Charcoal/Black

rovic

# RV1C COMPACT

- Stylish multi-feature console.
- Built-in accessory storage and cup holder.
- Quick push button folding system.
- Lightweight aluminium frame.
- Compact folding system.
- Soft grip handle.
- Umbrella holder.
- Hand brake.
- 2 x Accessory tabs.
- Wheels with posi-lock brakes.
- Folded dimensions: 33 x 38 x 60cm.



**TRRV1AWWH**  
Arctic/White



**TRRV1CLI**  
Charcoal/Lime



**TRRV1SBK**  
Silver



**TRRV1CBK**  
Charcoal/Black

# rovic RV2L LITE WEIGHT

- One action folding / unfolding.
- Lightweight, only 6.7kg.
- Adjustable saddles distance.
- Umbrella holder tube.
- 3 x accessory mount tabs.
- Cup holder plus.
- Alignment adjustable.
- Rear foot brake.
- 112 x 98 x 72cm (Unfolded).
- Folded dimensions: 33 x 74 x 41cm.



TRRV2LAWH Arctic/White



TRRV2LCLI Charcoal/Lime



TRRV2LCBK Charcoal/Black

# rovic RV3J JUNIOR

- Stylish compact console.
- Built-in accessory storage.
- 3 x Accessory tabs.
- Soft grip handle.
- Drinks holder.
- Golf ball holder.
- Wheels with posi-lock brakes.
- Lightweight aluminium frame.
- Folded dimensions: 36 x 34 x 78cm.



TRRV3JCBK Charcoal/Black



TRRV3JAWH Arctic/White

## Rovic Accessories

Wheel Cover TRRVAWC

Fits RV1C, RV1S.



Wheel Cover TRCCWC

Fits RV3J



Cooler Bag TRRVACB



Shoe Brush TRRVASB

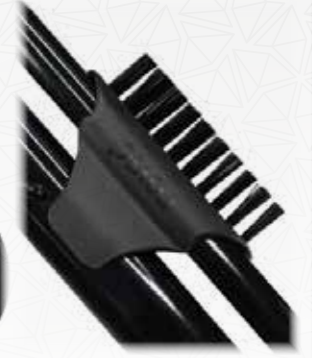

RV1C Cart Seat TRRVASEAT



RV2L Cart Seat TRRVA2LSEAT **New 2018**



2pk Hedgehog Sleeves TRHGWL003



Fits rear wheels of RV1C, RV1S, RV2L

# BagBoy



## BagBoy COMPACT 3

- Easy one-step handle adjustment accommodates golfers of all heights.
- Lightweight, weather resistant aluminium frame.
- Durable handlebar grip.
- Umbrella Holder.
- Accessory Bag attached to scorecard holder.
- Tee and ball marker holder.
- Integrated beverage holder.
- Handle mounted parking brake.
- Lightweight, solid foam maintenance free tyres.
- Simple three-step fold for compact storage.
- Folded dimensions: 46 x 33 x 55cm.



TRBBC3BR  
Matt Black/Red



TRBBC3SB  
Silver/Black  
New 2018



## TOP-LOK TECHNOLOGY



## INNOVATION

An innovative bag to cart attachment system designed to securely lock a Bag Boy bag onto a BagBoy push cart. This patented design prevents the bag from twisting or turning, eliminating the need for cart straps.

Available on most of the 2018 BagBoy Range. Look for the Top-Lok™ Technology logo.



Built-in Smart Phone Holder

46cm 33cm 55cm

Built-in Umbrella Holder

## BagBoy TRISWIVEL™ II

- Swivel Tech Technology allows the front wheel to swivel 360° offering the ultimate in manoeuvrability.
- Easy one-step handle adjustment accommodates golfers of all heights.
- Integrated umbrella storage.
- Tee and ball marker holder.
- Umbrella holder.
- Integrated beverage holder.
- Stand and cart bag friendly upper bag bracket with adjustable support arms.
- Lightweight, solid foam maintenance free tyres.
- Folded dimensions: 60 x 33 x 61cm.



TRBTSBR  
Matt Black/Red



## BagBoy QUAD XL

- Stand and cart bag friendly upper bag bracket with adjustable support arms lock the golf bag into place.
- Durable handlebar grip.
- Smart phone holder.
- Easy one-step handle adjustment accommodates golfers of all heights.
- Super compact for storage and transportation.
- Lightweight, solid foam maintenance free tyres.
- Integrated beverage holder.
- Tee and ball marker holder.
- Umbrella holder.
- Folded dimensions: 43 x 61 x 41cm.



TRBBQXLBR  
Matt Black/Red



Built-in Smart Phone Holder



**BagBoy**  
**TECHNOWATER®**  
**C-302** WEATHERPROOF  
 CART BAG

- 14-way top with full length individual divider system IDS®.
- Ergonomic handle integrated into bag top.
- Lightweight waterproof nylon.
- Fully sealed and taped waterproof seams.
- 9 functional Thermo-welded waterproof pockets provide ample storage including: Accessory pocket, Fleece-lined valuables pocket, Insulated cooler pocket, 2 full size garment pockets.
- SEAFORTH® custom fit waterproof rain hood.
- \*\*The Seaforth® Golf Bag Cover is the waterproof rain cover preferred by tour professionals around the world.
- Weight: 5.5 lbs



**14**  
WAY



TOP-LOK  
TECHNOLOGY  
GO  
STRAP  
LESS

INDIVIDUAL  
DIVIDER  
SYSTEM  
IDS

5.5 lbs



Easy access to your clubs,  
without the fuss!



Seaforth Rain hood  
Included



**BBCBTC302SCL**  
Slate/Charcoal/Lime



**BBCBTC302BS**  
Black/Silver



**BBCBTC302BCR**  
Black/Charcoal/Red

**BagBoy** New 2018  
**REVOLVER FX**  
 CART BAG

- 14-way multi-material rotating top with Clip-Lok™ technology and full length individual dividers.
- Grip-Lok Base holds clubs in place.
- Integrated trunk lift and lift-assist handles.
- Fully integrated umbrella sleeve.
- 7 zippered pockets including: Insulated cooler pocket, Fleece-lined valuables pocket with key holder, 2 full-length garment pockets with an IGOTCHA® Ball Retriever sleeve, Oversized ball pocket, 2 Accessory pockets.
- Cart strap sleeve allows bag to be secured without hindering pockets.
- Rubberised tee holder with tees included.
- Pen and divot tool holders.
- Rubberised traction feet.
- Rain hood with dual access.
- Shoulder strap holder.
- Weight: 9.7lbs.



**14**  
WAY

**360°**

TOP-LOK  
TECHNOLOGY  
GO  
STRAP  
LESS

INDIVIDUAL  
DIVIDER  
SYSTEM  
IDS

9.7 lbs



**BBCBRFXBRS**  
Black/Royal/Silver



14-way rotating top with  
Clip-Lok™ technology and  
full-length individual dividers



Grip-Lok™  
base holds  
clubs in place

# BagBoy LITE RIDER II CART BAG

- 14-way organizer top with full-length individual dividers.
- Soft-grip oversized putter well.
- Ergonomic soft-grip assist handles integrated into bag top.
- 7 zippered pockets including: 2 oversized apparel pockets Fleece lined valuables pocket, Oversized ball pocket Oversized insulated cooler pocket.
- Cart strap sleeve.
- Pen and towel ring holder.
- Umbrella holder.
- Rain hood included.
- Weight: 5.10 lbs.



**14  
WAY**

TOP-LOK  
TECHNOLOGY  
GO  
STRAP  
LESS

INDIVIDUAL  
DIVIDER  
SYSTEM  
**IDS**

**5.1 lbs**



# BagBoy C-500 CART BAG

New 2018

- 14 way organizer top with 3 full length individual dividers.
- Oversized putter well integrated into bag top.
- Easy grip handles integrated into top.
- Ergonomic padded shoulder strap.
- 5 zippered pockets including: Large apparel pocket, Ball pocket, Oversized insulated cooler pocket, Accessory pocket.
- Towel ring with Velcro® glove holder.
- Umbrella holder.
- Rain hood included.
- Lightweight.
- Weight: 4.5 lbs.



**14  
WAY**

INDIVIDUAL  
DIVIDER  
SYSTEM  
**IDS**

**4.5 lbs**



**BBCBLR2BC**  
Black/Charcoal



**BBCBLR2BCR**  
Black/Charcoal/  
Red



**BBCBLR2BCB**  
Black/Charcoal/  
Royal



**BBCBLR2NL**  
Navy/Lime



**BBCBC500BC**  
Black/Charcoal



**BBCBC500BL**  
Black/  
Charcoal/Lime



**BBCBC500BRB**  
Black/Royal/  
Silver



**BBCBC500BR**  
Black/White/  
Red

**BagBoy** New 2018  
**TECHNOWATER®**  
**S-259** WEATHERPROOF  
 STAND BAG

- 14-way top with full length individual divider system IDS®.
- Ergonomic handle integrated into bag top.
- Lightweight weatherproof nylon.
- Fully sealed and taped waterproof seams.
- 5 functional Thermo-welded weatherproof pockets provide ample storage.
- Cart friendly base.
- SEAFORTH® custom fit, waterproof, rain hood.
- \*\*The Seaforth® Golf Bag Cover is the waterproof rain cover preferred by tour professionals around the world.
- Weight: 6 lbs



**14**  
WAY



TOP-LOK  
TECHNOLOGY  
GO  
STRAP  
LESS

INDIVIDUAL  
DIVIDER  
SYSTEM  
IDS

6 lbs



Easy access to your clubs,  
without the fuss!



**BBSBTS259BG**  
Black/Grey



**BBSBTS259NWR**  
Navy/White/Royal



Seaforth Rainhood  
Included



**BBSBGLHBSRB**  
Black/Slate/Royal

**BagBoy** New 2018  
**GO LITE HYBRID**  
 STAND | CART BAG

- Use as a Cart or Stand Bag.
- 14-way top with full-length individual divider system IDS®.
- Easy-grip handle integrated into bag top.
- Lockable stand legs with slide-resistant traction feet.
- 6 zippered pockets including: Oversized insulated cooler pocket, Fleece-lined valuables pocket, 2 garment pockets, Large ball pocket, Accessory pocket.
- Riding and push trolley compatible base.
- Lift-assist handle.
- Pen and divot tool holders.
- Towel holder with Velcro® glove holder.
- Umbrella holder.
- Rain hood with dual access.
- Weight: 5.2 lbs

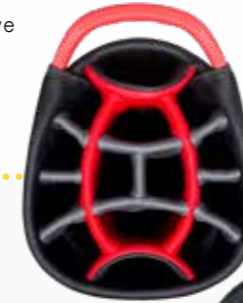

**14**  
WAY

TOP-LOK  
TECHNOLOGY  
GO  
STRAP  
LESS

INDIVIDUAL  
DIVIDER  
SYSTEM  
IDS

5.2 lbs



**BBSBGLHBSR**  
Black/Slate/Red



Compatible  
with trolleys

# BagBoy CARRY LITE PRO STAND BAG

- 8 way top with full-length individual dividers.
- Ergonomic handle integrated into bag top.
- 5 zippered pockets including: Large apparel pocket, Fleece lined valuables pocket, Oversized ball pocket.
- Insulated beverage sleeve.
- Ergonomic dual shoulder strap and hip pad for walking comfort.
- Riding and push cart compatible base.
- Rain hood and umbrella holder.
- Weight: 4.6 lbs.



**8  
WAY**

TOP-LOK  
TECHNOLOGY  
**GO  
STRAP  
LESS**

INDIVIDUAL  
DIVIDER  
SYSTEM  
**IDS**

**4.6 lbs**

# BagBoy New 2018 TREKKER STAND BAG

- 4 way organizer top with full length individual dividers (IDS).
- Soft-grip lift assist handle integrated into top.
- Ergonomic padded double shoulder strap and hip pad for walking comfort.
- Ultra-lightweight nylon.
- Towel holder.
- Umbrella holder.
- Rain hood with dual access.
- 5 zippered pockets including: Side panel pocket, Accessory pocket, Fleece lined valuables pocket, Full-size garment pocket, Full-size ball pocket.
- Insulated cooler sleeve.
- Lightweight durable stand legs with slide-resistant traction feet.
- Weight: 3.0 lbs.



**4  
WAY**

INDIVIDUAL  
DIVIDER  
SYSTEM  
**IDS**

**3.0 lbs**

**THE ULTIMATE**  
Lightweight stand bag  
ONLY  
**3 lbs**  
1.36kg



● **BBSTCLBC**  
Black/Charcoal



● **BBSTCLBCR**  
Black/Charcoal/Royal



● **BBSBTLBC**  
Black/Charcoal



● **BBSBTLBR**  
Black/Red



● **BBSBTLNL**  
Navy/Lime



● **BBSBTLCT**  
Charcoal/Turquoise



# BagBoy T-2000

WHEELED TRAVEL COVER



- Fits a 48" Driver and up to a 10" cart bag.
- Ergonomic patented Pivot-Grip® handle.
- Standguard™ high density foam padding.
- Extra thick wrap-around padded top for superior club protection.
- Lockable, full wrap-around main zipper simplifies access and packing.
- Oversized Shoe and Accessory pockets.
- 2 oversized Garment pockets.
- Internal compression strap stabilizes bag during travel.
- ID tag for easy identification.
- Durable nylon material.
- Dual lift-assist handles.
- Deluxe in-line skate wheels.
- Deluxe skid bars on back with durable skid resistant PVC base.
- Weight: 9lbs.



Improved **2018**



Ergonomic patented Pivot-Grip® handle twists to the bag position which reduces wrist & arm strain in transit

● **BBTCT2000CB**  
Charcoal/Black



# BagBoy T-10

HARD TOP TRAVEL COVER



- Hard ABS top for maximum club protection.
- Premium all-weather 600D polyester body.
- Padded trunk handle for easy lifting.
- Internal compression strap stabilizes bag during travel.
- Fits 48" driver and up to a 10" cart bag.
- Heavy duty anti-burst strap.
- Two oversized shoe/garment pockets.
- Durable skid resistant base.
- In-line skate wheels provide smooth rolling action.

Improved **2018**



● **BBTCT10HTBG**  
Black/Charcoal



● **BBTCT10HTBRB**  
Black/Royal Blue



● **BBTCT650BC**  
Black/Charcoal



● **BBTCT650BR**  
Black/Royal Blue

# BagBoy T-650

TRAVEL COVER

- Lockable, full wrap-around main zipper simplifies access and packing.
- Deluxe in-line skate wheels provide smooth rolling action.
- Reinforced corners for extra protection.
- Ergonomic neoprene handle for easy manoeuvring.
- Oversized shoe pocket.
- Internal compression strap stabilises bag during travel.
- Fits a 48-inch driver as well as most stand and cart bags.



**Pivot-Grip®**

Improved **2018**



**STANDGUARD™**

A uniquely designed internal high density foam padding to protect the stand bag mechanism while traveling.



**STANDGUARD™**

A uniquely designed internal high density foam padding to protect the stand bag mechanism while travelling.



Stores conveniently inside hard top for compact storage



Thick quilted top for maximum protection

# BagBoy RIKSHA® R-3000

## Rental Trolley

- Removable wheels and handle for flat storage and transport.
- Perfectly balanced for pushing or pulling.
- Corrosion resistant lightweight aluminium frame.
- Handle has 3 levels of height adjustment.
- Clubs sit upright making it easier to get in and out of the bag.
- Golf bag easily cradles into base of cart.
- Velcro strap to secure golf bag.
- Weight: 15 lbs.
- Folded dimensions: 86 x 51 x 27cm.



TRBBR3000  
Aluminium

## Riksha R3000 Rental Accessories

### Riksha Storage Basket

TRBBARSB



### Riksha Beverage Holder

TRBBARBH



# BagBoy ELECTRONIC TROLLEY ACCESSORIES

New 2018

## Universal 3-in-1 Cart Fan

TRBBAFA

- Energy-efficient 4-inch adjustable fan, mister, and power bank with built-in rechargeable battery.
- Secure mount fixes easily to existing umbrella holder ports.
- On/off water misting spray option.
- Powerful 3-speed, 2-inch fan blades.
- Detachable 4000 mAh portable battery charger bank powers any USB based device.
- Up to 5+ hours of battery life, depending on speed setting.
- Universal adapter clip and USB charging cable included. Allowing it to be fitted to nearly any make/model of riding or push trolley.



## Solar Charger

TRBBASC

- Lightweight 2-in-1 solar charger and power bank charges electronic devices via sunlight and incandescent light.
- Portable battery charger bank powers up to 2 USB based devices simultaneously.
- Powerful 5000 mAh battery.
- Only 5 hours to fully charge the solar charger via USB.
- Built-in LED flashlight by double tapping power button.
- Universal adapter clip and USB charging cable included. Allowing it to be fitted to nearly any make/model of riding or push trolley.



## Bluetooth Speaker

TRBBABS

- Lightweight wireless speaker streams audio from Bluetooth enabled devices.
- Wireless range: up to 32-feet.
- Rechargeable 750 mAh battery with up to 5 hours of battery life.
- Built-in volume adjustment to control from device or speaker.
- Universal adapter clip and USB charging cable included. Allowing it to be fitted to nearly any make/model of riding or push trolley.



**Tri Swivel II Carry Bag**  
TRBBATRCB



**Carry Bag**  
TRBBAQXLCB



Fits Quad XL, Compact 3

**Cart Seat**  
TRBBACS



**Backbone**  
BBTCBB



EXTENDS UP TO 54 INCHES

**Quad Dirt Bag**  
TRBBAQXLDDB



**Adjustable Umbrella Holder**  
TRBBAXLUH



Adjustable

**XL Umbrella Holder Extension**  
TRBBAXLUHE



Only fits Adjustable Umbrella Holder TRBBAXLUH

**2pk 12" Hedgehog Sleeves**  
TRHGWL003



Fits rear wheels of Quad XL, Tri Swivel II, Compact 3.

**2pk 10" Hedgehog Sleeves**  
TRHGWL001



Fits front wheels of Quad XL only.

**Winter Mittens**  
TRBBAWM



**Telescopic Wind Vent Umbrella**

- Umbrella extends 4" longer than standard umbrellas.
- Double vented canopy system prevents inversion in high winds.
- 62" diameter for maximum coverage.
- Push button auto open.
- Does not conduct electricity.
- Non-slip ergonomic cushion grip.
- Reinforced fiberglass shaft, ribs and hub.
- Velcro® closure straps.



HANDLE EXTENDS 4"



**UMBBWVRW** Red/White
  **UMBBWVBW** Black/White
  **UMBBWVNW** Navy/White
  **UMBBWVB** Black

**Mobile Device Holder**  
TRBBAMDH



**Sand/Seed Bottle**  
TRBBASSB



**Universal Beverage Holder**  
TRBBABUH



**Telescopic UV Umbrella**

- Umbrella extends 4" longer than standard umbrellas.
- Double vented canopy system prevents inversion in high winds.
- 62" diameter for maximum coverage.
- Push button auto open.
- Does not conduct electricity.
- Non-slip ergonomic cushion grip.
- Reinforced fiberglass shaft, ribs and hub.
- Velcro® closure straps.



HANDLE EXTENDS 4"



**UMBBUVVVS** Silver

2018

**BB SERIES**

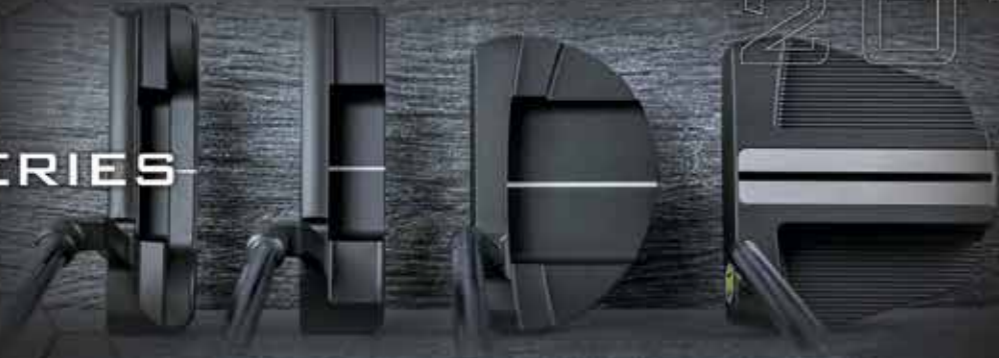

**NOVA**



**STUDIO STOCK SERIES**



*Queen B Series*



**H2 303 SS WEDGES**



**BETTINARDI** putters have amassed more than 50 worldwide professional wins since 1999. The best in the world trust Bettinardi with their most important club in the bag.

**THE PROCESS**

- Proudly made in the USA.
- Milled from a solid block of carbon steel.
- Manufactured in their own state-of-the-art CNC equipment facility.

**TOUR STAFF** PGA Tour Professionals using Bettinardi putters:



Matt Kuchar



Francesco Molinari



Haotong Li



Fred Couples



Jim Herman

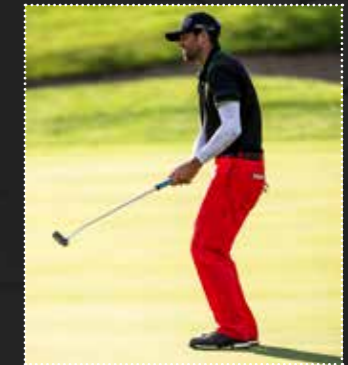

Ben Silverman

**FACE MILLING** Which best suits your game



**F.I.T. (Feel Impact Technology) Face**

- Softest feel at impact.
- For players with an aggressive putting style.
- Bettinardi milling process that eliminates inserts.

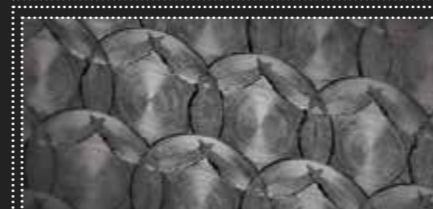

**Micro Honeycomb**

- Firm feel at impact.
- Made for players conscious of speed.
- Patented Bettinardi milling technology.

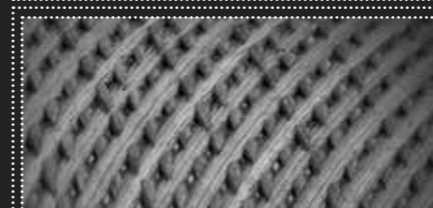

**Super-Fly Mill**

- Muted, yet responsive feel at impact.
- Made for players looking for both consistent speed and feel.
- Aggressive Bettinardi milling technology.

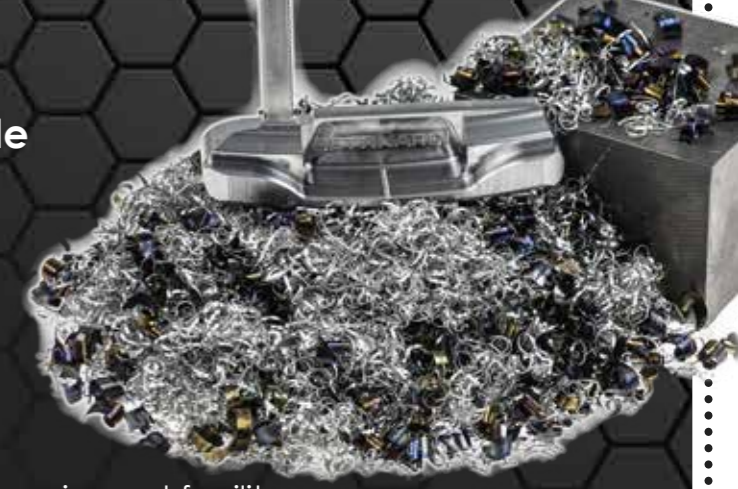

## BB SERIES

The BB Series has received unique cosmetic and performance upgrades for 2018 which includes the neck being moved slightly forward towards the sweet spot which helps promote less toe hang.

The traditional Honeycomb face has been replaced in favor of the aggressive Flymill milling technique, which produces a softer feel at impact.

A new Stealth Black finish is complimented with an electric yellow paint scheme, reducing glare and improving aim optics.

The BB1 series comes with a Flymill pattern headcover and a matching deep-etch cord Lamkin grip available in standard or jumbo sizes.



## BETTINARDI BB29 New 2018

New to the 2018 BB Series, this traditional heel-toe weighted blade features a squared frame, crowned topline and a mid-slant neck - all attributes designed to promote ideal hand positioning and locked in feeling at address. Milled from Soft Carbon steel, the aggressive Super-Fly face milling produces a softer feel than the previous Honeycomb pattern.



CODE	WEIGHT	GRIP	LIE/LOFT	LENGTH
BP18BB29S	350g	STD	71°/3°	UNCUT 38"
BP18BB29J	350g	JUMBO	71°/3°	UNCUT 38"
BP18BB2934S	350g	STD	71°/3°	34"
BP18BB2935S	350g	STD	71°/3°	35"
BP18BB2934J	350g	JUMBO	71°/3°	34"
BP18BB2935J	350g	JUMBO	71°/3°	35"

## BETTINARDI BB1 New 2018

The classic blade-style putter, has received unique cosmetic and performance upgrades for 2018 which includes a neck that has been moved slightly forward towards the sweet spot which promotes less toe hang. The traditional Honeycomb face has been replaced in favor of the aggressive Flymill milling technique, which produces a softer feel at impact.



CODE	WEIGHT	GRIP	LIE/LOFT	LENGTH
BP18BB1S	350g	STD	71°/3°	UNCUT 38"
BP18BB1J	350g	JUMBO	71°/3°	UNCUT 38"
BP18BB134S	350g	STD	71°/3°	34"
BP18BB135S	350g	STD	71°/3°	35"
BP18BB134J	350g	JUMBO	71°/3°	34"
BP18BB135J	350g	JUMBO	71°/3°	35"

## BETTINARDI BB1 | LEFT HANDED New 2018

The classic blade-style putter, has received unique cosmetic and performance upgrades for 2018 which includes a neck that has been moved slightly forward towards the sweet spot which promotes less toe hang. The traditional Honeycomb face has been replaced in favor of the aggressive Flymill milling technique, which produces a softer feel at impact.



CODE	WEIGHT	GRIP	LIE/LOFT	LENGTH
BP18BB1LHS	350g	STD	71°/3°	UNCUT 38"
BP18BB1LHJ	350g	JUMBO	71°/3°	UNCUT 38"
BP18BB1LH34S	350g	STD	71°/3°	34"
BP18BB1LH35S	350g	STD	71°/3°	35"
BP18BB1LH34J	350g	JUMBO	71°/3°	34"
BP18BB1LH35J	350g	JUMBO	71°/3°	35"

## BETTINARDI BB39 New 2018

The BB39 mallet, with its elongated flange and rounded edges, is the most visually striking putter in the new BB Series lineup. An extended flange increases the perimeter weight distribution for a consistently solid strike, while the elongated sightline simultaneously creates visual confidence at address. The craftsmanship that goes into making every Bettinardi unique is on full display with this new design.



CODE	WEIGHT	GRIP	LIE/LOFT	LENGTH
BP18BB39S	350g	STD	71°/3°	UNCUT 38"
BP18BB39J	350g	JUMBO	71°/3°	UNCUT 38"
BP18BB3934S	350g	STD	71°/3°	34"
BP18BB3935S	350g	STD	71°/3°	35"
BP18BB3934J	350g	JUMBO	71°/3°	34"
BP18BB3935J	350g	JUMBO	71°/3°	35"

## BETTINARDI BB56 **New 2018**

The body is milled from 6061 military grade aluminum and features a special topline weight made of 303 Stainless Steel. With the stainless steel weight directly behind and above the equator of the ball at address, along with a high MOI head shape, the Center of Gravity is raised, resulting in consistently solid contact and proper roll. Vented channel grooves on the sole and flange create an aerodynamic appearance at address.



CODE	WEIGHT	GRIP	LIE/LOFT	LENGTH
BP18BB56S	350g	STD	70°/2°	UNCUT 38"
BP18BB56J	350g	JUMBO	70°/2°	UNCUT 38"
BP18BB5634S	350g	STD	70°/2°	34"
BP18BB5635S	350g	STD	70°/2°	35"
BP18BB5634J	350g	JUMBO	70°/2°	34"
BP18BB5635J	350g	JUMBO	70°/2°	35"

## BETTINARDI BB56 | LEFT HANDED **New 2018**

The body is milled from 6061 military grade aluminum and features a special topline weight made of 303 Stainless Steel. With the stainless steel weight directly behind and above the equator of the ball at address, along with a high MOI head shape, the Center of Gravity is raised, resulting in consistently solid contact and proper roll. Vented channel grooves on the sole and flange create an aerodynamic appearance at address.



CODE	WEIGHT	GRIP	LIE/LOFT	LENGTH
BP18BB56LHS	350g	STD	70°/2°	UNCUT 38"
BP18BB56LHJ	350g	JUMBO	70°/2°	UNCUT 38"
BP18BB56LH34S	350g	STD	70°/2°	34"
BP18BB56LH35S	350g	STD	70°/2°	35"
BP18BB56LH34J	350g	JUMBO	70°/2°	34"
BP18BB56LH35J	350g	JUMBO	70°/2°	35"

## INOVAi 5.0 SERIES

Thanks to the success of its predecessors, the iNOVAi 5.0 looks to remain at the capstone example of Bettinardi craftsmanship and ingenuity.

Classic features that remain from previous iterations are the bi-metal construction, black anodized finish, and F.I.T. (Feel-Impact-Technology) Face.

The most noticeable new design characteristic is the hand polished 303 stainless steel weight which now creates a rounded mallet appearance, only adding to the steady strike attributes while increasing MOI numbers that this family of putters are known for.

The iNOVAi is available in both heel shafted and center-shafted options, and all iNOVAi models come with a special MOI headcover and matching deep-etch Lamkin grip in standard or jumbo sizes.



## BETTINARDI iNOVAi 5.0 **New 2018**

The Inovai putters feature a bi-metal technology in which the aluminum is anodized black, and the stainless steel is hand polished ensuring absolute smoothness. The two contrasting colors aid in alignment, in addition to distinguishing the use of two separate materials.



CODE	WEIGHT	GRIP	LIE/LOFT	LENGTH
BP18INO5S	358g	STD	70°/2°	UNCUT 38"
BP18INO5J	358g	JUMBO	70°/2°	UNCUT 38"
BP18INO534S	358g	STD	70°/2°	34"
BP18INO535S	358g	STD	70°/2°	35"
BP18INO534J	358g	JUMBO	70°/2°	34"
BP18INO535J	358g	JUMBO	70°/2°	35"

## BETTINARDI iNOVAi 5.0 | CENTER SHAFT **New 2018**

The Inovai putters feature a bi-metal technology in which the aluminum is anodized black, and the stainless steel is hand polished ensuring absolute smoothness. The two contrasting colors aid in alignment, in addition to distinguishing the use of two separate materials.



CODE	WEIGHT	GRIP	LIE/LOFT	LENGTH
BP18INO5CS	358g	STD	70°/2°	UNCUT 38"
BP18INO5CJ	358g	JUMBO	70°/2°	UNCUT 38"
BP18INO5C34S	358g	STD	70°/2°	34"
BP18INO5C35S	358g	STD	70°/2°	35"
BP18INO5C34J	358g	JUMBO	70°/2°	34"
BP18INO5C35J	358g	JUMBO	70°/2°	35"

## STUDIO STOCK SERIES

The Studio Stock Series is the direct evolution of classic putter designs, with enhanced characteristics. The foundation of the Studio Stock lineup is the mercury gray finish which provides rich and confidence inspiring looks at address. Each of the three models have been PGA Tour proven in look and feel with the FIT Face milling.

The SS3 offers a stout, compact mallet with a single bend shaft that frames the ball squarely at address.

The SS8 comes from the popular JAM head style featuring a high-toe topline and squared off edges.

The SS28 is a wide body, slight toe-hang blade which adds extra assurance that the putter will stay square through impact.

Combine these models with a matching headcover and corded grip, and you have a legacy lineup with striking characteristics.



## BETTINARDI SS3 | COUNTER BALANCE

The Studio Stock 3 Counterbalance offers more balance and stability than the traditionally weighted standard model. By increasing the head weight by 42 grams to 400 grams, and extending the length of the putter an additional 3 inches, the putter swings more stable than ever.



CODE	WEIGHT	GRIP	LIE/LOFT	LENGTH
BPSS3CB	400g	LAMKIN	70°/3°	UNCUT 46"
BPSS3CB36	400g	LAMKIN	70°/3°	36"
BPSS3CB37	400g	LAMKIN	70°/3°	37"
BPSS3CB38	400g	LAMKIN	70°/3°	38"

## BETTINARDI SS3

Another proven PGA Tour winner, the Studio Stock #3 is a much-requested addition to the lineup this year. Featuring a stout, compact look with slight toe hang, the famous F.I.T. (Feel Impact Technology) Face has been introduced resulting in a perfectly soft feel at impact.



CODE	WEIGHT	GRIP	LIE/LOFT	LENGTH
BPSS3	358g	STD	70°/3°	UNCUT 38"
BPSS3J	358g	JUMBO	70°/3°	UNCUT 38"
BPSS334S	358g	STD	70°/3°	34"
BPSS335S	358g	STD	70°/3°	35"
BPSS334J	358g	JUMBO	70°/3°	34"
BPSS335J	358g	JUMBO	70°/3°	35"

## BETTINARDI SS8

Perhaps our most classic offering, the Studio Stock #8 has seen numerous professional victories over the past decade. This distinct blade model joins an already proven collection with its popular plumbers neck, traditional perimeter bumpers, a subtle yet square high toe and our iconic F.I.T. (Feel Impact Technology) Face for softer feel.



CODE	WEIGHT	GRIP	LIE/LOFT	LENGTH
BPSS8	358g	STD	70°/3°	UNCUT 38"
BPSS8J	358g	JUMBO	70°/3°	UNCUT 38"
BPSS834S	358g	STD	70°/3°	34"
BPSS835S	358g	STD	70°/3°	35"
BPSS834J	358g	JUMBO	70°/3°	34"
BPSS835J	358g	JUMBO	70°/3°	35"

## BETTINARDI SS3 | LEFT HANDED

Another proven PGA Tour winner, the Studio Stock #3 is a much-requested addition to the lineup this year. Featuring a stout, compact look with slight toe hang, the famous F.I.T. (Feel Impact Technology) Face has been introduced resulting in a perfectly soft feel at impact.



CODE	WEIGHT	GRIP	LIE/LOFT	LENGTH
BPSS3LH	358g	STD	70°/3°	UNCUT 38"
BPSS3LHJ	358g	JUMBO	70°/3°	UNCUT 38"
BPSS3LH34S	358g	STD	70°/3°	34"
BPSS3LH35S	358g	STD	70°/3°	35"
BPSS3LH34J	358g	JUMBO	70°/3°	34"
BPSS3LH35J	358g	JUMBO	70°/3°	35"

## BETTINARDI SS28

The Studio Stock #28 has garnered multiple Tour wins and international competition appearances. The success of this design boils down to a well-proportioned look with a low profile face, wide body and slight toe-hang. This model is also available in either standard length options or with Arm Lock technology that eliminates the need to anchor while still delivering the utmost in stability and control.



CODE	WEIGHT	GRIP	LIE/LOFT	LENGTH
BPSS28	358g	STD	70°/3°	UNCUT 38"
BPSS28J	358g	JUMBO	70°/3°	UNCUT 38"
BPSS2834S	358g	STD	70°/3°	34"
BPSS2835S	358g	STD	70°/3°	35"
BPSS2834J	358g	JUMBO	70°/3°	34"
BPSS2835J	358g	JUMBO	70°/3°	35"

## BETTINARDI SS28 | ARMLOCK

The SS28 Arm Lock has been completely revamped to feature only 1 shaft of offset, with 5 degrees of loft. This gives golfers a cleaner look to the golf ball at address, while efficiently achieving the same results as the previous arm lock model. This putter is best used when the butt-end of the grip is placed two inches below the golfer's left forearm, and the shoulders swing to have a solid, locked in motion. Made with direct input from 7-Time PGA Tour winner Matt Kuchar.



CODE	WEIGHT	GRIP	LIE/LOFT	LENGTH
BPSS28ARM	400g	LAMKIN	71°/5°	UNCUT 46"
BPSS28ARM41	400g	LAMKIN	71°/5°	41"
BPSS28ARM42	400g	LAMKIN	71°/5°	42"

## BETTINARDI SS28 | CENTER SHAFT

Due to heavy demand, we have made our popular Studio Stock #28 model available in a center shaft option that still offers a slight toe hang preferred by most players. This alternative neck style easily places the shaft, eye line and center of the club face directly behind the ball for consistent alignment, repeatable performance and enhanced feel.



CODE	WEIGHT	GRIP	LIE/LOFT	LENGTH
BPSS28CS	358g	STD	70°/3°	UNCUT 38"
BPSS28CSJ	358g	JUMBO	70°/3°	UNCUT 38"
BPSS28CS34S	358g	STD	70°/3°	34"
BPSS28CS35S	358g	STD	70°/3°	35"
BPSS28CS34J	358g	JUMBO	70°/3°	34"
BPSS28CS35J	358g	JUMBO	70°/3°	35"

## QUEEN B SERIES

The Queen B Series was formed from a desire to fuse performance with sophistication, substance and grace.

Both the Queen B 8 and 9 models feature the Micro Honeycomb face milling and a light satin silver finish with swarming bees on the sole.

The Queen B 8 comes as a compact, mid-size blade with a semi-rounded notch milled into the flange, offering more weight displaced towards the heel and the toe.

The Queen B 9 gives mallet lovers a new look featuring a crescent milled neck and high-toe topline.

Paired with a white corded grip and matching headcover, the Queen B series remains desirable models for both men and women.



## BETTINARDI QB8

An entirely new design based on feedback from Tour players around the world, the Queen B #8 is the advancement of a classic mallet design with enhanced perimeter weighting, isolated in the rear bumpers and a squared profile. Its quarter toe hang will be favored by those with a slight arcing stroke while the Micro Honeycomb milled face delivers a muted, yet crisp feel at impact.



CODE	WEIGHT	GRIP	LIE/LOFT	LENGTH
BPQB8	362g	STD	70°/3°	UNCUT 38"
BPQB8J	362g	JUMBO	70°/3°	UNCUT 38"
BPQB834S	362g	STD	70°/3°	34"
BPQB835S	362g	STD	70°/3°	35"
BPQB834J	362g	JUMBO	70°/3°	34"
BPQB835J	362g	JUMBO	70°/3°	35"

## BETTINARDI QB9

The Queen B #9 was specifically designed for the player with a more broadly arcing stroke who prefers rounded and soft aesthetics. This model combines the best of the signature Bettinardi design principles with a gentle sweeping toe and crescent milled neck to complement the compact and curved appearance.



CODE	WEIGHT	GRIP	LIE/LOFT	LENGTH
BPQB9	362g	STD	70°/3°	UNCUT 38"
BPQB9J	362g	JUMBO	70°/3°	UNCUT 38"
BPQB934S	362g	STD	70°/3°	34"
BPQB935S	362g	STD	70°/3°	35"
BPQB934J	362g	JUMBO	70°/3°	34"
BPQB935J	362g	JUMBO	70°/3°	35"



## H2 303 SS WEDGES

CC

This new technology pushes the USGA groove limits, and offers tighter spin in both wet and dry conditions. Robert's preferred C-Groove remains constant as a versatile sole grind, making it easy to open up around the green for soft flop shots, or hitting knock-downs from the fairway.



## BETTINARDI H2 303SS New 2018

Fitted with KBS Hi Rev, and paired with a Lamkin Crossline corded grip. shaft True Temper Dynamic Gold S200 available on request.



**Patented Honeycomb Milling**

ASSEMBLED	HEAD CODE	BOUNCE	RH/LH	LIE/LOFT	LENGTH
BP18W303SS50	BP18W303H50	8°	RH	64°	35 1/2"
BP18W303SS52	BP18W303H52	8°	RH	64°	35 1/2"
BP18W303SS54	BP18W303H54	10°	RH	64°	35 1/4"
BP18W303SS56	BP18W303H56	12°	RH	64°	35 1/4"
BP18W303SS58	BP18W303H58	10°	RH	64°	35"
BP18W303SS60	BP18W303H60	8°	RH	64°	35"

## BBI SERIES BBI | BB29 | BB39 | BB56

	BBI	BB29	BB39	BB1	Enhanced Designs
LOFT	3°	3°	3°	3°	Classic head shapes with modern refinements for stronger performance benefits.
LIE	70°	70°	70°	70°	
STOCK LENGTHS	33", 34", 35", UNCUT (38")	33", 34", 35", UNCUT (38")	33", 34", 35", UNCUT (38")	33", 34", 35", UNCUT (38")	<b>Material</b> Soft carbon steel allows for the most memorable feel at impact.
HEAD MATERIAL	SOFT CARBON	SOFT CARBON	SOFT CARBON	6061 ALUMINIUM/303 STAINLESS	
HEAD FINISH	STEALTH BLACK	STEALTH BLACK	STEALTH BLACK	STEALTH BLACK	<b>Feel</b> Super-Fly mill facing offers improved feedback for a softer, crisper feel at impact.
OFFSET	FULL SHAFT	FULL SHAFT	FULL SHAFT	FULL SHAFT	
GRIP	DEEP ETCH LAMKIN CORD	DEEP ETCH LAMKIN CORD	DEEP ETCH LAMKIN CORD	DEEP ETCH LAMKIN CORD	<b>Deep Etch Corded Grip</b> Classic Bettinardi grip, now with cord for added feel.
HEADCOVER	ELECTRIC YELLOW & BLACK	ELECTRIC YELLOW & BLACK	ELECTRIC YELLOW & BLACK	ELECTRIC YELLOW & BLACK	
CUSTOM LOFT	2° +/-	2° +/-	2° +/-	2° +/-	<b>Stepless Shaft</b> Offers a cleaner view at address.
CUSTOM LIE	3° +/-	3° +/-	3° +/-	3° +/-	
					<b>Headcover</b> Matches the electric yellow paint schematics with a durable Velcro enclosure.

## INOVAI 5.0 5.0 | 5.0 CENTER SHAFT

	3.0 and CENTER SHAFT	COUNTERBALANCE	Enhanced Designs
LOFT	2°	2°	Fusing motion science with detailed craftsmanship.
LIE	70°	70°	
STOCK LENGTHS	33", 34", 35", UNCUT (38")	36", 37", 38", 39", 40" UNCUT (41")	<b>Material</b> 6061 Aluminium and 303 Stainless Steel.
HEAD MATERIAL	6061 ALUMINIUM AND 303 STAINLESS STEEL	6061 ALUMINIUM AND 303 STAINLESS STEEL	
HEAD FINISH	BLACK ANODIZED AND HAND POLISHED STAINLESS	BLACK ANODIZED AND HAND POLISHED STAINLESS	<b>Feel</b> F.I.T. (Feel-Impact-Technology) Face milling allows for the softest possible milled putter.
OFFSET	FULL SHAFT	FULL SHAFT	
GRIP	LAMKIN DEEP ETCH	LAMKIN DEEP ETCH	<b>Lamkin Deep Etch Grip</b> Classic Bettinardi with a soft deep feeling grip in standard and jumbo size.
HEADCOVER	BLACK AND RED	BLACK AND RED	
			<b>Stepless Shaft</b> Offers a cleaner view at address.
			<b>Headcover</b> The Inovai headcover to match the black and red colour scheme, with a durable Velcro enclosure.

## STUDIO STOCK SS3 | SS8 | SS28 | SS28 CENTER SHAFT

	Studio Stock #3, 8, 28	Studio Stock #28 ARMLOCK	Studio Stock #28 CENTER SHAFT	Enhanced Designs
LOFT	3°	5°	3°	Classic head shapes and sleek profiles with stronger performance benefits.
LIE	70°	71°	70°	
STOCK (RH) LENGTHS	33", 34", 35", UNCUT (38") (CB 46")	40", 41", 42", UNCUT (46")	33", 34", 35", UNCUT (38")	<b>Material</b> Soft carbon steel allows for the most memorable feel at impact.
STOCK (LH) LENGTHS	SS#3 ONLY 33", 34", 35", UNCUT (38")			
HEAD MATERIAL	SOFT CARBON	SOFT CARBON	SOFT CARBON	<b>Feel</b> F.I.T. (Feel-Impact-Technology) Face milling allows for the softest possible milled putter.
HEAD FINISH	MERCURY GREY	MERCURY GREY	MERCURY GREY	
OFFSET	FULL SHAFT	FULL SHAFT	NONE	<b>Deep Etch Corded Grip</b> Classic Bettinardi with cord for added feel.
GRIP	BLUE CORD	15" BLUE CORD	BLUE CORD	
HEADCOVER	GREY AND BLUE	GREY AND BLUE	GREY AND BLUE	<b>Stepless Shaft</b> Offers a cleaner view at address.
CUSTOM LOFT	2° +/-	2° +/-	2° +/-	
CUSTOM LIE	3° +/-	3° +/-	3° +/-	<b>Headcover</b> Matches the Mercury Grey finish with a durable Velcro enclosure.
COUNTERBALANCE OPTION	SS#3 ONLY			
COUNTERBALANCE LENGTHS	36"-40"			

## QUEEN B QUEEN B 8 | QUEEN B 9

	Queen B #8	Queen B #9	Enhanced Designs
LOFT	3°	3°	Meticulously engineered head shapes with performance added features.
LIE	70°	70°	
STOCK LENGTHS	33", 34", 35", UNCUT (38")	33", 34", 35", UNCUT (38")	<b>Material</b> Soft carbon steel allows for the most memorable feel at impact.
HEAD MATERIAL	SOFT CARBON	SOFT CARBON	
HEAD FINISH	SATIN SILVER	SATIN SILVER	<b>Feel</b> Micro Honeycomb face milling gives a distinct, crisp feel at impact.
OFFSET	FULL SHAFT	3/4 SHAFT	
GRIP	WHITE CORD	WHITE CORD	<b>Deep Etch Corded Grip</b> Classic Bettinardi with cord for added feel.
HEADCOVER	WHITE AND GOLD	WHITE AND GOLD	
CUSTOM LOFT	2° +/-	2° +/-	<b>Stepless Shaft</b> Offers a cleaner view at address.
CUSTOM LIE	3° +/-	3° +/-	
			<b>Headcover</b> Intricately embroidered Queen B headcover effortlessly matches the sole of both Queen B models featuring black and gold color accents.

USA Milled

All putters are milled, painted, and assembled in our own facility.

Weighting

Precision milled from a solid block of steel gives perfect balance and stability.

PGA Tour Proven

Bettinardi putters have amassed over 50 worldwide wins.

### Options available for custom fitting Bettinardi Putters

Lie/Loft and Length can all be customized. This can be requested when ordering, or can be customized using a loft/lie bending machine.

The putters can typically bend 4-5 degrees comfortably in either direction, on both lie and loft.

Putters can be cut and gripped anywhere from 33"-38", however most customers typically order between 33"-35". The lie and length is the most important.

If balance needs to be changed, weight can be adjusted with putter grip/lead tape. Superstroke grips with counter weight is also an option.

# BETTINARDI HEADCOVERS



**BB BLADE** BP18PCBBB    **BB Mallet** BP18PCBBM    **BB MOI** BP18PCBBMOI    **iNOVAi** BP18PCBBMOI  
**BB SERIES** BP18PCBBB    **BB SERIES** BP18PCBBM    **BB SERIES** BP18PCBBMOI    **BB SERIES** BP18PCBBMOI  
**QUEEN BEE** BP18PCBBB    **QUEEN BEE** BP18PCBBM    **QUEEN BEE** BP18PCBBMOI    **QUEEN BEE** BP18PCBBMOI  
**STUDIO STOCK** BP18PCBBB    **STUDIO STOCK** BP18PCBBM    **STUDIO STOCK** BP18PCBBMOI    **STUDIO STOCK** BP18PCBBMOI

# PUTTER DISPLAY STAND

CODE	UNIT SIZE	WEIGHT	CAPACITY
BPPOS12	35"x15"x 34"	28lbs	12 Clubs



# BETTINARDI BANNERS

**BPBANUS** - USA Banner    **BPBANSS** - Studio Stock  
**BPBANEU** - Europe banner    **BPBANQB** - Queen Bee  
**BPBANCO** - Corporate banner    **BPBANBB** - BB Series  
**BPBANCO1** - Corporate banner    **BPBANWE** - Wedges



• PVC 90x60cm  
 • Rings in every corner

# BETTINARDI STAFF CART BAG

- Nylon Denim and Polyurethane bag.
- Lightweight cart bag.
- Polyester lining.
- Denim fabric exterior.
- 8.5" diameter.
- 5 top diameter with full-length club dividers.
- Unique double slope top design.
- Unique No-Twist bottom designed to integrate with all makes and models of Carts.
- 11 functional pockets.
- Large cooler compartment.
- Rubber foot cart base.
- Extra large ball pocket.
- Transportation handle for easy lifting.

**5 WAY**



# LAMKIN DEEP-ETCHED GRIPS

STUDIO STOCK SERIES

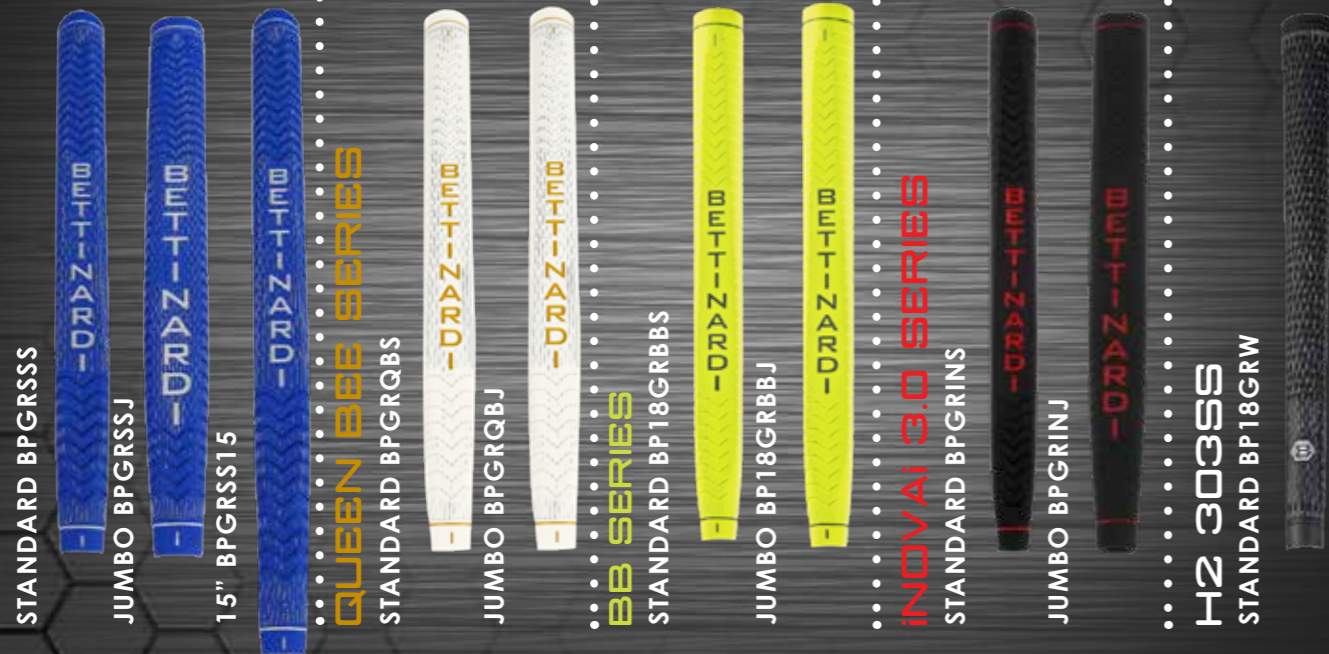

**STANDARD** BPGRSS    **QUEEN BEE SERIES** BPGRQB    **BB SERIES** BPGRQB    **INOVAI 3.0 SERIES** BPGRINJ    **H2** 303SS  
**JUMBO** BPGRSSJ    **STANDARD** BPGRQS    **JUMBO** BPGRQBJ    **JUMBO** BPGRINJ    **STANDARD** BP18GRW  
**15" BPGRSS15**    **QUEEN BEE SERIES** BPGRQB    **BB SERIES** BPGRQB    **INOVAI 3.0 SERIES** BPGRINJ    **H2** 303SS  
**STANDARD** BPGRQS    **JUMBO** BPGRQBJ    **BB SERIES** BPGRQB    **INOVAI 3.0 SERIES** BPGRINJ    **H2** 303SS  
**STANDARD** BP18GRBBS    **JUMBO** BP18GRBBJ    **BB SERIES** BP18GRBBS    **INOVAI 3.0 SERIES** BP18GRBBJ    **H2** 303SS  
**STANDARD** BP18GRBBS    **JUMBO** BP18GRBBJ    **BB SERIES** BP18GRBBS    **INOVAI 3.0 SERIES** BP18GRBBJ    **H2** 303SS



● **BPSCBSI** Silver    ● **BPSCBBK** Black    ● **BPSCBBL** Blue

**Fastfold**  
**FLATFOLD**

- Extreme flat folding system.
- Large Scorecard holder.
- Elastic cart straps.
- Umbrella holder base.
- Footbrake.
- Unfolded dimensions: 112 x 72 x 122cm.
- Folded dimensions: 78 x 60 x 20cm.



TRFFFCGR  
Charcoal/Green

TRFFFCRD  
Charcoal/Red

TRFFFSBK  
Silver/Black

TRFFFCBK  
Black

**EZEGLIDE**  
**COMPACT**

- Easy to open and fold.
- Soft grip handle.
- Multi-function console.
- Tough durable frame.
- Adjustable handle height.
- 11.5" rear wheels, 9.5" front wheel.
- Foot brake.
- Weight only 5.8Kg.
- Folded dimensions: 56x49,5x35,5cm.



TREZC3CL  
Charcoal/Lime



TREZC3SL  
Silver



**EZEGLIDE**  
**COMPACT**  
**QUAD**

- 4 wheel stability on all terrains.
- Simple 2 step folding with foot operated lever.
- Weatherproof console with ball and tee holder.
- Lightweight aircraft grade aluminium frame.
- Easily adjustable handle with comfort grip.
- Integrated press on/off foot brake.
- Folded dimensions: 63x35x31cm.

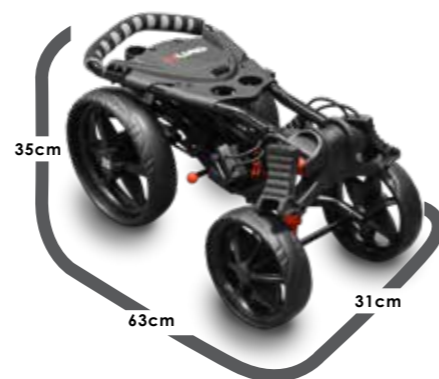

**EZEGLIDE**  
**SMART-FOLD**

- Premium 3 wheel trolley.
- One touch easy fold down.
- Multi-feature scorecard holder with dry space for valuables and equipment.
- Trueglide ball bearing wheels retractable front wheel for easy storage.
- Easy to use foot brake lightweight durable aluminium frame.
- Adjustable handle height and bag bracket.
- Includes umbrella holder and wheel covers.
- Folded dimensions: 79 x 58 x 40cm.



TREZSF3BK  
Black

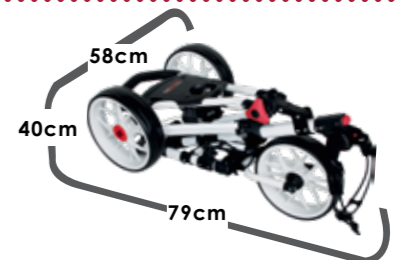

## EZEGLIDE CRUISER

- Easy push design reduces strain.
- Soft grip handle with adjustable handle height.
- Wide axle for extra stability.
- 10" true glide ball bearing wheels with foot brake.
- 2 stage easy fold design.
- Folded dimensions: 94 x 34 x 61cm.
- Colour box.



TREZW White

TREZB Black



## EZEGLIDE JUNIOR CRUISER

- Adjustable bag height bracket (minimum bag height 63cm).
- Integrated ball line up tool, pencil, tees and score card holder.
- Quick release wheels for easy storage.
- Adjustable handle angle.
- Adjustable handle length.
- Suitable for 4-14 years.
- Folded dimensions: 89 x 42 x 46cm.



TRJU3 Black



## EZEGLIDE TRI+

New 2018

- Soft grip handle.
- Multi-function console.
- Weather proof multi-function scorecard holder with storage for tees, balls, pencil and small accessories.
- Tough durable frame and high load capacity.
- Drinks holder.
- Adjustable handle height.
- Bag support.
- Retractable front wheel.
- Easy fold design.
- Foot brake.
- Folded dimensions: 89 x 39 x 34cm.



TREZLCR Charcoal/Red

TREZLCB Charcoal/Blue

## Longridge Tri Cart

- Easy push design reduces strain.
- Soft grip handle.
- Weather proof scorecard holder.
- Multi-function console.
- Tough durable frame.
- Adjustable handle height.
- Durable nylon bag brackets.
- 11" True glide ball bearing wheels.
- 2 stage easy fold design.
- Foot brake.
- Folded dimensions: 90 x 48 x 45cm.



TR3WD Black

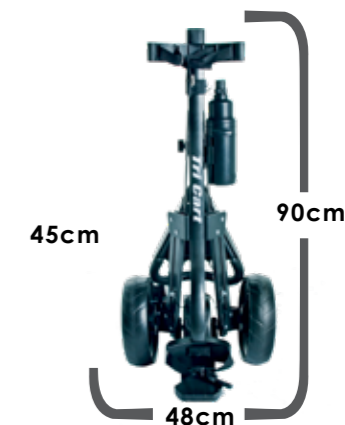

**longridge**  
**Microlite**

- Ultra compact tri-fold trolley.
- Simple snap 'n' click assembly.
- Adjustable handle height.
- Quick release wheels.
- 9" wheel span.
- Scorecard, golf ball & accessory holder.
- Folded dimensions: 65 x 38 x 34cm.



TRCOSN  
Aluminium

**longridge**  
**Alu Pro**

- Ultra lightweight frame.
- Weather proof scorecard holder.
- Tough durable frame.
- Adjustable handle height.
- Durable nylon bag brackets.
- 11" True glide ball bearing wheels.
- Easy fold design.
- Foot brake.
- Folded dimensions: 98 x 40 x 38cm.
- Brown box.



TRAL3  
Aluminium

**longridge**  
**Deluxe Junior**

- Quick release wheels.
- Adjustable height bag bracket.
- Folded dimensions: 88 x 48 x 34cm.



TRJU  
Black

**longridge**  
**Rental**

- Heavy duty steel frame.
- Wide wheels with bearings.
- Removable bag bracket.
- Security loop.
- 11" wheels.
- 2 years guarantee.
- Durable handle.
- Spares available including body, wheels & brakes.



TRRENSW  
Spare Wheel

TRRENBB  
Spare Bag Bracket

TRREN3W  
Front Wheel Only

New 2018

TRREN  
Steel

**longridge**  
**Tri Lite**

- Strong lightweight frame.
- Scorecard holder.
- Ball & tee holder.
- Folded dimensions: 88 x 34 x 37cm.
- Brown box.



TRALLN  
Aluminium

**longridge**  
**Pro Lite**

- Scorecard, ball & tee holder.
- Anti-splay wire.
- Quick release wheels.
- Strong & durable.
- Folded dimensions: 90 x 47 x 33cm.
- Brown box.



TRDSL N  
Black

**Trolley Accessories**

**Golf Trolley Bag**

TRTCD

- Keeps your car boot clean of mud.
- Large size will fit most trolleys.
- Strong durable material.
- 53w x 32d x 93h cm.



**Electric Trolley Carry Bag**

TRELDC

- Double straps for easy handling.
- Heavy duty with ventilation holes.
- 70w x 45d x 95h cm.
- Fits Motocaddy, Hillbilly, PowaKaddy and many more.



**Universal 2-3-4 Wheel Covers**

TRWC

- Easy fit waterproof wheel cover.
- Elasticated cover fits up to 12" wheels.
- Storage pouch included.
- Fits 2-3-4 wheels, pouch can be used for 4th wheel.



**Elasticated Trolley Straps**

TRES



**Trolley Straps with Clips**

TRTS



**Clip/Carabiner**  
BACARBINER 5.5cm  
BACARBINERM 4cm



**Putter Caddy 3-in-1**

BAPC



Trolley Accessories

**Trolley Umbrella Holder**

**TRUH**

- Compatible with most square, round, and oval frames.
- Easily attaches to trolley.
- Adjustable angles.



**Universal Umbrella Holder**

**TREKUHD**

- Heavy duty durable.
- Compatible with most trolleys.
- Easily attaches to trolley.
- Adjustable angles.



Washers enable holder to fit most trolleys.

**Extender Umbrella Holder** New 2018

**TRUHXL**

- 15cm extender for umbrella holder.
- Compatible with most umbrella holder.
- Easily attaches.



**Eze Glide Umbrella Holder**

**TREZUH**

- Easily adjustable.
- Fits in-built adapter on console.
- Holds all golf umbrellas.
- Fits: Masters Icart, Icart 1 & 2, Big Max, Stuart Z1, Qwik Fold, Fast Fold.



Fully adjustable front, back and side to side.

**Collapsible Cooler Bag**

**TRACCB**

- Collapsible & easy to store in golf bag.
- Insulated bag keeps drinks & snacks cool.
- Easy access velcro top.
- Holds 2 x 500ml bottles/4 x 330ml cans.



**Drinks Holder**

**TREKDH**

- Lightweight strong and durable.
- Easy to install quick lock/release bracket.
- Holds cans, cups and bottles.
- No tools required.



**Universal Accessory 3pc Kit**

**TREKTP**

- Set includes All Weather Phone Holder, Drinks Holder & GPS Holder.
- All accessories come with an easy to install adjustable mountable system.
- Fits: Samsung S7, S7 Edge, iPhone 4, 5, 6 & 6 plus.



**All Weather Phone Holder**

**TREKAWC**

- Protection in all weather conditions.
- Touch screen friendly.
- Fits: Samsung S7, S7 Edge, iPhone 4, 5, 6 & 6 plus.
- 3 Foam inserts for secure fit.
- Adjustable rotating mount.
- Easy grip zip.



**Clicgear GPS Holder**

**TRCCAGPS**

- 2-side rubber for upper & higher position.
- Works with umbrella holder.
- Made to fit cart perfectly.
- Easy installation of GPS.



**Bracketron Golf Bag GPS Holder**

**BABGPSH**

- Clips easily & securely to your golf bag.
- Fits most golf GPS & smart phones.
- Portable design to easily fit in golf bag.
- Grip-It arms expand up to 4.5" wide.
- Includes optional mounting adapter to attach directly to your GPS device.



**Helps protect fairways.**  
**Reduces surface contact by up to 75%.**  
**Avoids winter trolley bans.**  
**Increases grip and traction.**  
**Available for both electric and push trolleys.**



For BagBoy Quad XL, TRHGWL001 & TRHGWL003 Must be ordered together

**Hedgehog Sleeve Kits**



- Fits over a standard trolley wheel.
- No tools required.
- Kits contain wheel sleeves + clips.



CODE	SUITABLE FOR	DESCRIPTION	KIT CONTAINS	FITS WHEELS
TRHGWL001	BagBoy Quad XL	2pk 10" Hedgehog Sleeves	2 x 10"	Front Only
TRHGWL003	BagBoy Quad XL	2pk 12" Hedgehog Sleeves	2 x 12"	Rear Only
TRHGWL003	BagBoy Tri Swivel II	2pk 12" Hedgehog Sleeves	2 x 12"	Rear Only
TRHGWL003	BagBoy Compact 3	2pk 12" Hedgehog Sleeves	2 x 12"	Rear Only



- Fits over a standard trolley wheel.
- No tools required.
- Kits contain wheel sleeves + clips.



CODE	SUITABLE FOR	DESCRIPTION	KIT CONTAINS	FITS WHEELS
TRCCAHW	Clicgear Model 3.5+	3pk Hedgehog Sleeves	3 x 14"	Front & Rear
TRHGWL003	Rovic RV1C	2pk 12" Hedgehog Sleeves	2 x 12"	Rear Only
TRHGWL003	Rovic RV1S	2pk 12" Hedgehog Sleeves	2 x 12"	Rear Only
TRHGWL003	Rovic RV2L	2pk 12" Hedgehog Sleeves	2 x 12"	Rear Only
TRCCAHC	All models	Spare clip for Hedgehog Sleeve		

**Hedgehog Wheel Kit**



- Replaces standard trolley wheels.
- Kits contain 4 solid wheels.



CODE	SUITABLE FOR	DESCRIPTION	KIT CONTAINS	FITS WHEELS
TRCCAHW8	Clicgear Model 8	4pk Hedgehog Wheels	4 Solid wheels	Front & Rear

**longridge**

**Aqua**  
Waterproof Cart Bag

- Bag is waterproof when rain hood is used.
- Coated nylon fabric with waterproof zipper and taped seams.
- 9.5" Top with 15 way full length divider and integrated putter holder.
- Towel and umbrella holder.
- 2 lift handles.
- 9 pockets including full length clothes pocket.
- Weight: 2.3kg.

**15**  
WAY



**2.3**  
kg



Waterproof Zips & Seams



**BA9GCBWBW**  
Black/Red



**longridge**

**Pro**  
Cart Bag

- Stay quiet 'V' iron slots keeps clubs snug and prevent damage.
- 9.5" Top with two tiered design to keep clubs organised.
- Lightweight material.
- 15 Way divider system.
- Extra tall, 1 metre high.
- 10 Easy access pockets.
- Allows irons to slot in.
- Side lift handles.



**15**  
WAY



RATTLE FREE



**BA9KPCBBN**  
Black/Navy



"V" Slot Top holds clubs in place



**BA9KPCBBW**  
Black/White

**longridge**

**Executive**  
Cart Bag

- Easy access organiser top.
- 15 way full length divider with integrated putter holder.
- 9 pockets including full length clothes pocket.
- 2 lift handles.
- Towel and umbrella holder.
- Weight: 2.3kg.



**15**  
WAY

**2.3**  
kg



**BA9GCEBS**  
Black

**BA9GCEBB**  
Black/Navy

**longridge**  
**Weekend**  
**6" Stand Bag**

- Compact but can hold 14 clubs!
- Lightweight only 1.7kg.
- Graphite friendly 4 way dividers.
- 5 pockets including bottle holder & large clothes pocket.
- Adjustable dual straps.
- Padded hip pad.
- Rain hood included.

● **BAS6WNS**  
Black/Navy

● **BAS6WBS**  
Black/Silver



**longridge**  
**Sunday**  
**5" Golf Bag**

- Ultra lightweight golf bag, only 1.37kg.
- Shoulder strap & carry handle.
- 2 zipped pockets.
- 1 mesh accessory pocket.
- Holds 6 clubs.
- Removable hood.

 **1.37 kg**

● **BA5SN**  
Black/Navy

● **BA5S**  
Black/Silver



**longridge**  
**X-Lite**  
**5" Golf Bag**

- Ultra light golf bag, only 660 grams.
- Compact, lightweight carry bag.
- 3 zipped pockets including full length clothes pocket.
- Accessory pocket & umbrella holder.
- Padded carry strap.

● **BA5PXBB**  
Black/Navy

● **BA5PXBS**  
Black/Silver



**longridge**  
**Travelite**  
**5" Stand Bag**

- Ultra light golf bag, only 1.84kg.
- 2 zipped pockets.
- 1 mesh accessory pocket.
- Shoulder strap & carry handle.
- Holds 6 clubs.
- Removable hood.

 **1.84 kg**

● **BAS5TNS**  
Black/Navy

● **BAS5TBS**  
Black/Silver



**longridge**  
**Pencil**  
**5" Golf Bag**

- Compact, light weight carry bag.
- Full length apparel pocket.
- Includes accessory pocket & umbrella holder.
- Easy to carry dual strap.
- Removeable accessory pocket suitable for logo.

● **BA5P**  
Black/Navy

● **BA5PBS**  
Black/Silver



LOGO FRIENDLY  
Detachable  
Logo Panel



**longridge**  
**Hard Case**  
**Travel Cover**

- Heavy duty ABS construction.
- Foam padded top.
- Easy glide roller wheels.
- Full Wrap around heavy duty lockable zipper.
- 2 retractable handles.
- Large size: 126 x 32 x 37cm.

  
● **BATCHF**  
Silver

**2018** modification





**longridge**  
**Tour Deluxe**  
**Roller travel Cover**

- 360° travel protection.
- In-line skate wheels.
- Extra padded top and sides.
- Removable panel for logo.
- Multi-point carry handle.
- Shoulder strap.
- Includes lock.



**LOGO FRIENDLY**

Detachable  
Logo Panel



**BATCRDN**  
Black/Navy

**longridge**  
**Compact**  
**Four Wheel Travel Cover**

- Generous size fits most cart bags.
- Four ball bearing wheels.
- Compact folding size.
- Includes padlock with key code.
- 3 padded carry handles.
- 2 accessory pockets.
- Size: 136 x 37 x 32cm.



**BATCR4WB**  
Black/Silver

**longridge**  
**Storm**  
**Bag Rain Cover**  
BARCDM



- Use on Electric and Manual Trolleys.
- Large rain cover, keeps bag/clubs dry.
- Easy wrap on fit whilst on trolley.
- Fits on stand and cart bags.
- Compact and lightweight.
- Folds down into carry bag.



**longridge**  
**Storm**  
**Bag Cape**  
TRELAC



- Use on Electric and Manual Trolleys.
- Waterproof protection for all golf equipment.
- Easy wrap on fit whilst on trolley.
- Heavy duty construction.
- Folds down into pouch pocket.



**longridge**  
**Storm**  
**Bag Rain Hood**  
BARHSH



- Universal Weather Golf Bag Protector.
- All weather protection for golf clubs.
- Easy zip access to the clubs.
- Elasticated neck fits all golf bags.
- Lightweight fabric.
- Compact and easy to store.



In-line Skate Wheels



**BATCRDB**  
Black/Silver



Compact folding size



**BATCR4WN**  
Navy/Silver

**MULTI-ACCESS PREMIUM RAIN COVER**

**longridge**  
**Deluxe**  
**Bag Rain Cover**

**BARCD**

- Multi Access Premium Rain Cover.
- Premium quality.
- Easy fit.
- Golf club access.
- Side pocket access.
- Ball pocket access.
- Storage pouch.
- Multi-zip access.
- Quality PVC material.



**longridge**  
**Standard**  
**Bag Rain Cover**

**BARC**

- Keeps bag & equipment clean & dry.
- Zipper top for fast access to clubs.
- Easy to fit even whilst on trolley.
- Compact & stores away in carry pouch.



**longridge**  
**Easy**  
**Bag Rain Cover**

**BARCE**

- Fits most golf bags.
- Easy access to most pockets & clubs.
- Easy to fit with velcro fasteners.
- Waterproof, lightweight and compact.



**SPALDING** TRUE TO THE GAME

New 2018

**SPALDING TRUE BLACK SET - MAN**

- This True Black package from SPALDING features all the latest technology to take your game to the next level!
- Massive 460cc driver features high launch loft technology and discretionary peripheral weighting to optimise accuracy and distance.
- Fairway wood has a high MOI and deep centre of gravity to launch the ball higher and longer.
- Hybrid has a wide sole design and weight in the heel and toe to optimise forgiveness.
- Woods and hybrids are all powered by Low torque graphite shafts for maximum distance and control.
- Irons feature a WIDE SOLE & deep undercut cavity for maximum forgiveness from any type of lie.
- Putter is heel/toe balanced for greater control.
- 460CC Driver - HL - Regular Flex Graphite Shaft
- 3 Fairway Wood - Regular Flex Graphite Shaft
- 24 Degree #4 Hybrid - Regular Flex Graphite Shaft
- 6 to SW Irons - Regular Flex Steel Shafts - Wide Sole - Oversized Design - Deep Cavity
- Putter - Heel/Toe balanced
- 3 Head Covers
- 9" Deluxe Stand bag Black/White, with 7 way divider, cooler pocket, bag hood.



PAFSSP Mens  
PAFSSSP1 Mens +1"



**longridge**  
**VL<sup>4</sup> COMPLETE 18PC PACKAGE**

**PAFSVL731GR**

- Mens 1, 3, and 5 woods.
- All graphite shaft.
- Hybrid wood 4.
- Stainless steel iron heads 5-SW.
- Two ball putter with steel shaft.
- 4 Co-ordinated head covers.
- Mens 8.5" stand bag.



**longridge**  
**VECTOR**

**COMPLETE PACKAGE 12 piece WITH TROLLEY**

**PAVECT**

- Package includes:  
 460cc Alloy Driver + Headcover,  
 #3 Alloy Fairway wood + Headcover,  
 Alloy Hybrid 21° wood,  
 5 Irons (7-SW),  
 Putter,  
 Cart Bag,  
 Steel trolley.
- Accessories:  
 2 plastic pitchforks,  
 6 plastic ball markers,  
 3 golf balls,  
 12 tees.

**Trolley, Tees, Balls & Pitchforks Included in Complete Package**



**longridge**  
**VECTOR**

**PACKAGE 12 piece**

**PAFSVECTM12 Mens  
 PAFSVECTL12 Ladies**

- Package includes:  
 460cc Alloy Driver + Headcover,  
 #3 Alloy Fairway wood + Headcover,  
 Alloy Hybrid 21° wood, 5 Irons (7-SW),  
 Putter, Cart Bag.



**longridge**  
**VECTOR**

**PACKAGE 8 piece**

**PAFSVECTM8 Mens  
 PAFSVECTL8 Ladies**

- Package includes:  
 #3 Alloy Fairway wood + Headcover,  
 Alloy Hybrid 21° wood, 5 Irons (7-SW),  
 Putter, Cart Bag.

**Available in mens, Ladies and left handed**



The Longridge VL4 Complete Package provides the golfer with a complete 18 piece package.

The set comprises of a 400cc VL4 Titanium Matrix Driver and Titanium Matrix fairway woods. The stainless steel hybrid with 21° of loft, with its back weighted head and extra wide sole provides versatility and playability from all lies.

The hyper steel irons are a two piece construction for long lasting durability. The twin disc mallet putter is a modern design with an easy alignment system and a polymer face insert for softer feel and control.

The set comes complete with 3 Long neck deluxe wood covers, hybrid cover, a putter cover, a durable lightweight stand bag with a dual shoulder strap and a graphite friendly top.

RIGHT HAND VL4 CLUBS AVAILABLE INDIVIDUALLY			
CLUB	CODE	SHAFT	MENS
#5 IRON	IRVL5	SS	●
#7 IRON	IRVL7	SS	●
#7 IRON	IRVL7GR	GPH	●

8 PIECE, 12 PIECE SET				
	MENS 8PC SET	LADIES 8PC SET	MENS 12PC SET	LADIES 12PC SET
460CC DRIVER GPH + HEADCOVER			●	●
#3 FAIRWAY GPH + HEADCOVER	●	●	●	●
#5 HYBRID GPH	●	●	●	●
IRONS (S/S SHAFTS)	7,9,PW		6,7,8,9,PW	
IRONS (GPH SHAFTS)		7,9,PW		6,7,8,9,PW
PUTTER	●	●	●	●
CART BAG	●	●	●	●
RH CODE	PAFSVECTM8	PAFSVECTL8	PAFSVECTM12	PAFSVECTL12
LH CODE	PAFSVECTM8LH	PAFSVECTL8LH	PAFSVECTM12LH	PAFSVECTL12LH

INDIVIDUAL CLUBS				
	CLUB	SHAFT	RH CODE	LH CODE
MENS	#6 IRON	SS	IRVE6	IRVE6LH
MENS	#8 IRON	SS	IRVE8	IRVE8LH
LADIES	#6 IRON	GPH	IRVEL6GR	IRVEL6GRLH
LADIES	#8 IRON	GPH	IRVEL8GR	IRVEL8GRLH
MENS/LADIES	#1 WOOD GPH + HEADCOVER	GPH	WOVE1GR	WOVE1GRLH
LADIES	#1 WOOD GPH + HEADCOVER	GPH	WOVE1GR	WOVE1GRLH

Note: It is possible to add extra driver, 6 Iron, 8 Iron & also possible to change configuration.

**BOYS & GIRLS SETS**

- All sets come with the following as standard:  
Maximum distance driver, Stainless steel irons, Putter, Co-ordinated headcovers, Dual strap lightweight stand bag.
- Colour box.



13-16 Boys  
● JUP13GR  
Navy



13-16 Girls  
● JUPL13GR  
Pink



12+  
● JUPCH12GR  
Green



8+  
● JUPCH8GR  
Orange



4+  
● JUPCH4GR  
Yellow



3+ Boys  
● JUPCH3GR  
Camouflage



3+ Girls  
● JUPCHL3GR  
Pink

**ALL SETS COME WITH COLOUR CO-ORDINATED CLUBS AND SHAFTS**



CLUB	13-16 BOYS 7 PC SET	13-16 GIRLS 7 PC SET	12+ 6 PC SET	8+ 5 PC SET	4+ 4 PC SET	3+ BOYS 3 PC SET	3+ GIRLS 3 PC SET
MAXIMUM GPH DISTANCE DRIVER	460CC	460CC	•	•	•	•	•
3 WOOD GPH	•	•					
HYBRID WOOD GPH	•	•	•				
IRONS GPH SHAFTS	7, 9, SW	7, 9, SW	7, 9, PW	7, 9, PW	7, 9	7	7
PUTTER	HIGH M.O.I MALLET	HIGH M.O.I MALLET	•	•	•	•	•
STAND BAG	•	•	•	•	•	•	•
HEADCOVERS	•	•					
CART BAG	JUP13GR	JUPL13GR	JUPCH12GR	JUPCH8GR	JUPCH4GR	JUPCH3GR	JUPCHL3GR

longridge

# TIGER PLUS JUNIOR SET

- The ideal golf set for budding golfers.
- Tiger Set Plus is specifically designed for juniors.
- Clubs are fitted with graphite junior flex shafts & lighter golf heads.
- Lightweight stand bag with dual straps for carrying with ease.



The Junior Tiger Plus Package provides the budding young golfer with an excellent starter set for the game. The Oversize Titanium Matrix 3 wood will give them maximum confidence from the tee and combined with the Oversize Titanium Matrix 7, P/S irons and mallet style putter with soft face insert, they have all they need to really enjoy the game.

AGE	RH/LH	#3 WOOD	#7 IRON	#P/S	PUTTER	BAG	CODE
4-7 YRS	RH	•	•		•	•	JUPTP4GR
8-11 YRS	RH	•	•	•	•	•	JUPTP8GR
12-14 YRS	RH	•	•	•	•	•	JUPTP12GR
4-7 YRS	LH	•	•		•	•	JUPTP4GRLH
8-11 YRS	LH	•	•	•	•	•	JUPTP8GRLH
12-14 YRS	LH	•	•	•	•	•	JUPTP12GRLH

## JUNIOR TIGER PLUS CLUBS AVAILABLE INDIVIDUALLY

AGE	RH/LH	#7 IRON	#9 IRON	P/S IRON
4-7 YRS	RH	JUIR7GR4	JUIR9GR4	JUIRPSGR4
8-11 YRS	RH	JUIR7GR8	JUIR9GR8	JUIRPSGR8
12-14 YRS	RH	JUIR7GR	JUIR9GR	JUIRPSGR
12-14 YRS	LH	JUIR7GRLH	JUIR9GRLH	JUIRPSGRLH

AGE	RH/LH	#3 WOOD	PUTTER
4-7 YRS	RH		JUPUT4
8-11 YRS	RH		JUPUT8
12-14 YRS	RH	JUWO3GR	JUPUT
12-14 YRS	LH	JUWO3GRLH	JUPUTLH

## Junior Accessories



### Rovic RV3J Junior

● TRRV3JCBK Charcoal/Black

○ TRRV3JAWH Arctic/White

- Stylish compact console.
- Built-in accessory storage.
- Quick compact fold design.
- Soft grip handle.
- Golf ball holder.
- Drinks holder.



### Eze Glide Junior Cruiser

● TRJU3 Black

- Adjustable handle.
- Multi-function console.
- Quick release wheels.
- Suitable for 4-14 years.



### Longridge Deluxe Junior

● TRJU Black

- Quick release wheels.
- Adjustable bag bracket.
- Colour box.



## Junior Tiger Golf Club Set 3-5 yrs

### JUSPT3GR

- Specifically designed for younger golfers.
- #3 Wood.
- #7 Iron.
- Mallet putter.
- Golf bag soft side with padded Strap.



## Junior Plastic Golf Set & Trolley Bag

### PAJPGSD

- Driver.
- Iron.
- Putter.
- 5 Balls 2 tees.
- 2 Putting cups with flag.
- Plastic trolley bag.



## Junior All Weather Glove

GLAWJU1S Small  
GLAWJU1M Medium  
GLAWJU1L Large

- Junior left handed.



## Wedges, Chippers & Putter

### Tour Spin Black Wedge

WETSB52 52° WETSB60 60°  
WETSB56 56° WETSB64 64°

- Super spin grooves and large sole for maximum feel and control.
- Stainless steel with black finish.



### Tour Spin Satin Wedge

WETS52 52° WETS60 60°  
WETS56 56° WETS64 64°

- Super spin grooves and large sole for maximum feel and control.
- Stainless steel with satin finish.



### Two Way Chipper

CHTW Silver

- Dual face chipper with nickel finish.
- Suitable for right / left handed players.

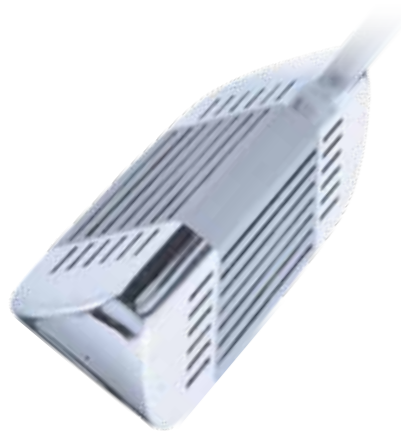

### 1-5 Ball Chipper

CH2B Silver

- One and half disc alignment aid.
- Wide sole for smooth, consistent hits.



### Tour Chipper

CHTOUR Silver  
CHTOURLH Silver / Left Hand

- Low face profile for extra height.
- Heavy and low centre of gravity.
- Alignment line for increased accuracy.



### Super I Blade Putter

PUSP1 Black

- More forward roll on impact increased accuracy and consistency vibration dampened for soft touch.



Super Lite Oversize Grip

### Super II Mallet Putter

PUSP2 Black

- More forward roll on impact increased accuracy and consistency vibration dampened for soft touch.



Super Lite Oversize Grip

### Bat Wing Putter

PUBW Gun Metal

- Split disc alignment.
- Bat wing shaped putter head.
- Low centre of gravity for straighter putt.



### One Ball Putter

PUIOB Silver

- 86.5cm shaft.
- Split disc alignment.



### Milled Face Putter

PUMI Silver

- Dual face chipper with nickel finish.
- Suitable for right / left handed players.



### Two Way Bullseye Putter - Brass Finish

PUTWB Brass Look

- Can be used right or left handed.
- 86.5cm shaft.
- Ideal for rental.



### Two Way Bullseye Putter - Silver Finish

PUTW 85.5cm  
PUTW31 78cm Junior Length

- Ideal for rental or juniors.
- Can be used right or left handed.



### Adventure Golf Rubber Putters

- Mini Golf Putter.
- Perfect for 'Crazy Golf' or 'Pitch & Putt'.



- JUPURRD Red 24"
- JUPUROR Orange 27"
- JUPURBK Black 33"
- JUPURGN Green 30"

### 50pk Low Bounce Golf Balls

- 50% bounce. For crazy mini golf low bounce.

New 2018



• BLLGB50W White

**MAGNET+X**  
EASY MAGNETIC CLOSURE

**Driver Headcovers**

**WC1MDR Black**

- Long neck shaft protection.
- Magnetic closure allows easy opening.
- Fits oversized 460cc driver.
- Detachable logo top panel.



(Pitchfork and tees not included).



Easy Magnetic Closure



**MAGNET+X**  
EASY MAGNETIC CLOSURE

**Wedge Headcovers**

**ICLNMW Black**

- Premium club head protection.
- Magnetic seal allows easy opening and self closing.
- Lightweight and durable with soft inner lining.

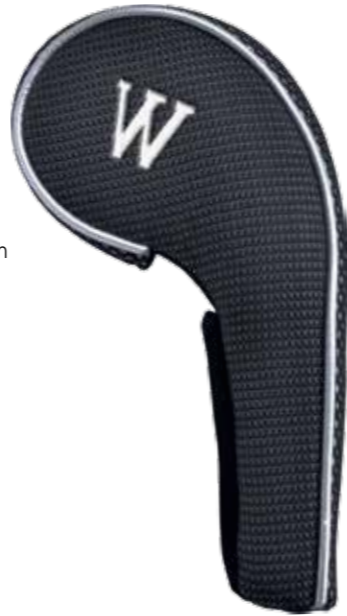

**MAGNET+X**  
EASY MAGNETIC CLOSURE

**9 piece Iron Headcovers**

**ICLNM Black**

- Fits oversized irons.
- Long neck for shaft protection.
- 9 piece set (3-SW) with magnetic closure for easy opening.



**MAGNET+X**  
EASY MAGNETIC CLOSURE

**Fairway Headcovers**

**WCMFW Black**

- Premium club protection.
- Magnetic closure allows easy opening.
- Fits 3, 4, 5.



Easy Magnetic Closure



**MAGNET+X**  
EASY MAGNETIC CLOSURE

**Hybrid Headcovers**

**WCMHYB Black**

- Premium club protection.
- Magnetic closure allows easy opening.
- Fits 3, 4, 5.



Easy Magnetic Closure



**9 piece Neoprene Iron Headcovers**

**ICNEBD Black**

- Protects club face and includes velcro closure.
- Fits oversized irons.
- Durable 9 piece set (4-GW).



**9 piece Neoprene Longneck Iron Headcovers**

**ICLNNBR Black/Silver**

- Fits oversized irons.
- Zipped black neoprene.
- Long neck for shaft protection.
- Durable 9 piece set (4-GW).



**MAGNET+X**  
EASY MAGNETIC CLOSURE

**Blade Putter Cover**

**PCMBP Black**

- Premium club protection.
- Magnetic closure allows easy opening.



**MAGNET+X**  
EASY MAGNETIC CLOSURE

**Mallet Putter Cover**

**PCMMP Black**

- Premium club protection.
- Magnetic closure allows easy opening.



**9 piece Graphite Longneck Iron Headcovers**

**ICLNNT Black**

- Fits oversized irons.
- Long neck for shaft protection.
- Durable 9 piece set (4-GW).
- Two tone black material.



**3 piece Longneck Wood Headcovers**

- **WC3LB Black 3pc**
- **WC3LN Navy 3pc**

- Fur wood covers.
- Interchangeable numbers 1, 3, 5, 7, X.
- Long neck hosel protection.



## EZEGOVER IRON COVERS

- Fits oversized irons.
- Long neck for shaft protection.
- 10 Piece set (4-GW).
- Zipped black neoprene.



ICNEBWBW  
Black/White



ICNEBWBO  
Black/Orange



ICNEBWBS  
Black/Silver



ICNEWBWB  
Black

ICNEBWB  
Black/Lime

## Classic Headcovers New 2018

- WCVDR Black
- WCVFW Black
- WCVHY Black

- Classic style headcover.
- Durable PU leather with fleece lining.
- Side stretch panels for secure fit.
- Fairway & Hybrid come with number tag.



Number Tag



## Long John Pom Pom Cover



WCNOPPDR  
Driver

WCNOPPFW  
Fairway

WCNOPPHYB  
Hybrid

WCNOPPDRBR  
Driver

WCNOPPDRBL  
Driver

## Club Hugger Headcovers

- Fits 460cc driver.
- Clips on to shaft.



WCCHPIG Pig

WCCHDOG Dog

WCCHGOPH Gopher

WCCHFROG Frog

WCCHBDOG Bulldog

## Novelty Headcovers



WCNOLEP Leprechaun

WCANOBG Boxing Glove

WCANLN Loch Ness



## Spalding Hybrid Glove

- Leather palm and thumb for feel with lycra inserts.
- Powerful grip that is reliable and durable.
- Ventilation and flexibility
- Magnetic ball marker included.



White	Mens Left Handed	<b>GLSH</b>	S,M,ML,L,XL
White	Ladies Left Handed	<b>GLSHL</b>	S,M,L
White	Junior Left Handed	<b>GLSHJ</b>	S,M,L



## Colin Montgomerie Pro Feel Hybrid Glove

- Cabretta leather palm for feel.
- Stretch lycra knuckle for superb fit.
- Breathable synthetic back.
- Durable long lasting performance.
- Includes magnetic ballmarker.

White	Mens	<b>CMGLCADFW</b>	S,M,ML,L,XL
White	Ladies	<b>CMGLCADFLW</b>	S,M,L



COLIN MONTGOMERIE

## Pull Up Winter Mittens

### GLWMF

- Super fleece keeps hands warm between shots.
- Pair.



## Glove Shaper

### GLGS

- Designed to fit the shape of an open palm.
- Extend the life of golf glove.
- Clip to golf bag.



## Pro Sports Tape

### GAPSTM Mens

### GAPSTL Ladies/Kids

- Adhesive pre-cut finger strip tape.
- Protects against skin abrasion & leaves no sticky mess behind. Stretch comfort & lasts for hours.



## Tour Dry All Weather Glove

- Leather palm and thumb for feel.
- Ergonomic fit with lycra inserts.
- Breathable stay cool design.
- Magnetic ball marker included.

White	Mens Left Handed	<b>GLAWW</b>	S,M,ML,L,XL
White	Mens Right Handed	<b>GLAWRH</b>	S,M,ML,L,XL
Black	Mens Left Handed	<b>GLAWB</b>	S,M,ML,L,XL
White	Ladies Left Handed	<b>GLAWLW</b>	S,M,L



## Junior All Weather Glove

- Junior left handed.

Large	<b>GLAWJU3L</b>	
Medium	<b>GLAWJU2M</b>	
Small	<b>GLAWJU1S</b>	



## Dri Max Winter Gloves

### GLWP Mens GLWPL Ladies

- Thermal fabric for winter protection.
- Windproof.
- Reinforced palm patch.
- Sizes: Mens: S/M/L/XL Ladies: S/M/L.
- Pair.



## Winter Mittens

### GLWME

- Black fleece lined for winter protection.
- Velcro adjustable straps.
- Water resistant.
- Hooks to attach to golf bag or clothing.
- Pair.



## Heat Pack Hand Warmer

### GAHW40

- Up to 8 hours of warmth for hands.
- Odourless, safe & disposable.
- Packed in pairs.
- 40 Pairs display box.



## Reusable Hand Warmer

### GAHWR2

- 2 x Reusable hot hand warmers.
- Snap metal disc inside to activate heat.
- To reuse boil in hot water for 10 mins.
- Heat pack size : 10 x 7 x 1 cm.



Snap to activate the heat



Heats up to 50-54°C

## Straw Hat

### HRHWSSH

- Natural with black band.



## Calypso Sun Lotion Display Box

### HAUVCAL24

- 7.5g Sachet, Factor 30.
- 5\* High protection from UVB & UVA
- Fragrance free
- 24 Sachet display box





**Shot Scope V2**  
GAGPSS

## WORLD'S SMARTEST GOLF WATCH

GPS watch with industry-leading automatic performance tracking.

As advertised on Sky Sports Golf!

- Industry-leading Smart GPS chip provides accurate distances to the F/M/B of greens and hazards
- ClubSense™ Technology collects the location of each shot and the club used
- PinCollect™ Technology for accurate pin location
- Only fully automated performance tracking system for golf
- Access over 40,000 courses worldwide, ready to play and track
- Highest grade commercial GPS

### DYNAMIC YARDAGES

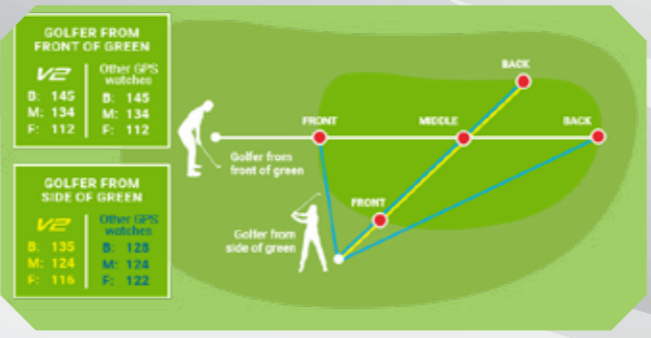

- No Subscription**
- Conforms to the Rules of Golf**
- Works Worldwide**



**DYNAMIC YARDAGES**   **GPS AND PERFORMANCE TRACKING**   **TOUR-LEVEL ANALYTICS**

### The Shot Scope V2 system



#### Shot Scope Watch

- F/M/B distances to the green
- Distance in meters or yards
- Dynamic distances to/over hazards
- Industry-leading putting statistics

#### Tags

- Set of 20 tags screw into the end of each grip
- No phone or manual tagging required on course
- Differentiate between real swings and practice swings

#### Apps

- Free iOS, Android and desktop apps
- View every shot plotted onto an aerial view of the course
- View stats for club, Tee shots, Approaches, Short Game and Putting



### No phone, no tagging, just play

LONGEST DRIVE: 306yds  
Score: 4  
AVG SCORE: 4.3

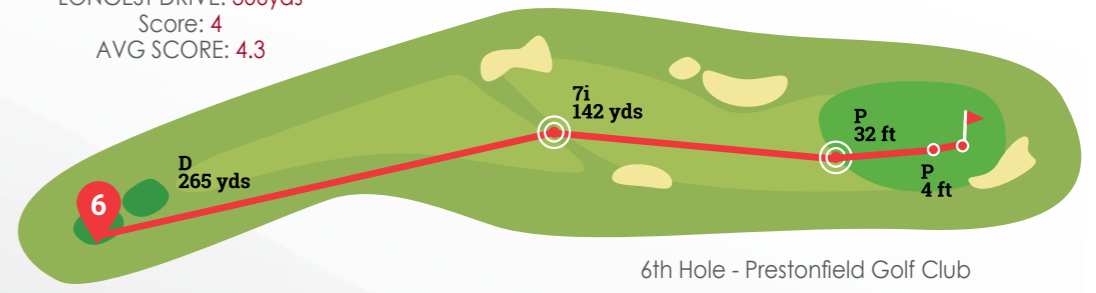

#### Performance Dashboard

- Shot Scope's Tour-level performance dashboard helps the golfer to understand and improve their golf game



#### Over 100 Tour-Level Statistics

- Club distances, averages and performance distances
- Fairway hit or missed including left and right analysis
- Green success from fairways, rough and bunkers
- Proximity to hole statistics for approaches and short game
- Shots to finish statistics
- Up and down percentage
- Percentage of short game shots to finish inside 6ft and 20ft
- Average putts per round including holing out percentage
- Personal records

## L4 Laser Rangefinder

GADFLVCL4

New 2018



- Slope integration.
- Continuous scan mode
- Shock resistant.
- Stabilization.
- Vibration on target capture.
- Water resistant.
- Highest quality Optics and processor.
- Measuring range: 50-1000 yards



Ultra Responsive High Speed Reading

## PT30 Putting Trainer

New 2018

GAVCPT30

- Real time putting analysis.
- Instant Feedback LCD display.
- Smart scoring-Automatic Scorecard
- Measures: putting distance, ball direction, face angle, putting tempo



## T2 Golf GPS Tracking Watch



Golf GPS Course Tracking Auto Scoring Running Mode Cycling Mode

- Course tracking.
- Yardage to the front/centre/back of the green.
- Digital Scorecard: Auto Scoring.
- Sleek and sophisticated body design.
- Swing analysis: Swing Tempo Practice.
- Watch feature: time, date, alarm, stopwatch.
- Automatic course/ hole recognition.
- Save position (User ID point).
- Stats/ history review (score, fitness data).
- Access to fitness data during golf play.
- 30,000 courses preloaded and 40,000 worldwide.
- Water resistant 30M (IPX7).
- No subscription fee or additional fees.
- Rechargeable battery (10 hours with GPS, 6 weeks without GPS).



Scorecard

● GAGPSVCT2B Black



## T1 Golf & Fitness GPS Watch



Golf GPS Swing Tempo Scorecard Running Mode Cycling Mode

- Golf GPS: Distance to the green (front/centre/back).
- Swing Analysis: swing tempo practice.
- Digital Scorecard: score and play history.
- Fitness Watch: speed, distance, calories burned.
- Time, date, alarm and stopwatch.
- Automatic course recognition.
- Automatic hole recognition.
- Rechargeable battery (10 hours with GPS, 6 weeks without GPS).
- 30,000 courses preloaded and 40,000 worldwide.
- No additional fees, no hidden costs.

○ GAGPSVCT1W White



● GAGPSVCT1B Black



## Swing Caddie Launch Monitor SC200



Voice Output Swing Speed Ball Speed Smash Factor

- Distance voice output.
- Select loft angle with each club.
- Instant feedback via LCD display.
- Practice swing measurement.
- Air pressure sensor to Calibrate and give most accurate reading.
- 3 modes: Practice, Target, Random.
- Daily and overall stats for each club.
- Shot count and time display.
- Simultaneous display: Carry distance, Swing speed, Ball speed, Smash factor.
- Package includes: User manual, Remote Control, 4 X AAA Batteries.



● GAGPSSCLMSC2B Navy



## Voice Caddie SC200 Protective Case

GAGPSSC2CA



## SC200 Dummy Unit

GAGPSSC2DUM



## Voice Caddie SC200 POS

GAGPSSC2POS



## Voice Caddie Display Unit

- Suitable for Voice Caddie products.
- Lockable with 2 keys.
- Storage compartment.

GAGPSVCPOS



## Swing Caddie Launch Monitor SC100

- Standalone device (no phone app needed).
- Instant feedback via LCD display.
- Measures: Carry distance, swing speed, ball speed, smash factor.
- 3 modes: Practice, Target, Random.
- Stats for each club.
- Average stats.
- Shot count and time display.
- No additional fees, no hidden costs.
- Package includes: User Manual, Remote Control, 4 X AAA Batteries.

● GAGPSSCLMSC1B Black  
○ GAGPSSCLMSC1W White



## VC300SE Voice Output Golf GPS

- Voice output golf distance measuring device.
- Distance to the front/centre/back of the green.
- Shot distance measurement.
- Automatic course/hole recognition.
- Multilingual: 9 languages.
- Hands-free operation-clip to a cap or belt.
- Volume control.
- Rechargeable battery (8 hours of continuous use).
- 30,000+ courses preloaded.
- No additional fees, no hidden costs.
- Includes magnetic ballmarker.

○ GAGPSVC3W White



● GAGPSVC3B Black



## Longridge Mini 400-C Laser Range Finder with Micro USB Charging

### GADFL5 White

- Ultra compact & lightweight.
- Rechargeable via micro USB connector (supplied).
- 400m range easy point & shoot operation, quickly scans distances.
- Pintracker function automatically detects the flag and ignores other rear targets.
- Size: 80 x 65 x 40mm.
- Weight: 145 grams.

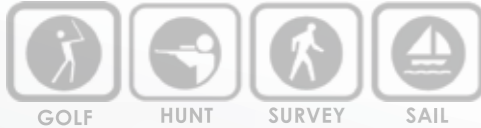

## Longridge 800-S Laser Range Finder

### GADFL4 White

- Scan-Function.
- Rubber armoured construction.
- 6 X magnification.
- 800m range.
- LCD display.
- Weight 208 grams.
- Size: 115 x 74 x 39 mm.



LCD Display  
With a 800m range, the LCD display can read targets in yards and metres.



Focusing Eyepiece  
Measurements are displayed on a LCD display and can be viewed through a focus adjustable eyepiece.

## Pin Point Laser Range Finder

### GADFL1 Black

- Rubber armoured construction.
- 6 X magnification.
- 400m range.
- LCD display.
- Weight 200 grams.
- Size: 70mm x 40.5mm x 110mm.

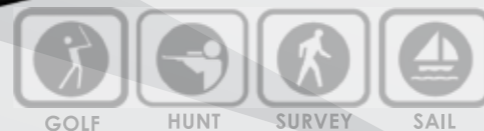

## Laser Link Range Finder RH2

### GADFLRH2 Silver/Red

- Distance to any target on the golf course.
- Pistol-shaped for ease of use.
- Red Dot Aiming System featuring Zero-In Alignment Aid.
- Large, easy-to-read LCD.
- Three confirmation settings: Audio, Silent, & Vibrate.
- Measures in yards or meters (Measures distance only).
- Increased Range – measurements up to 1000 yards.
- Easy to store and carry.
- Only 6.4 ounces including battery.
- Improved optics and electronics for faster and more accurate measurements.
- Ergonomically designed rubberized grip.

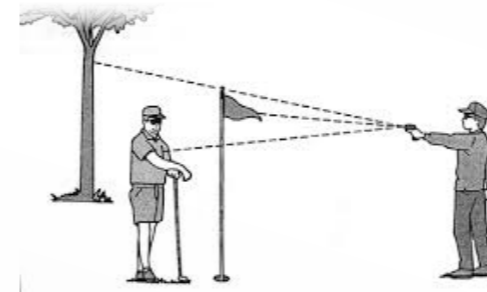

## Scoreband Pro Tour Edition 5-in-1 Scorekeeping Watch

- Track hole and round scores.
- Running total of strokes view.
- Post-Round summary of: Front 9, Back 9 and scorecard style (hole by hole).
- 3 ATM Water resistance.
- Backlight digital screen.
- Low battery indicator with replaceable lithium battery.
- 'Hibernate' function to conserve battery life.
- One year warranty.

- GASCBSPLBK Black S
- GASCBSPBK Black L
- GASCBSPLWH White S
- GASCBSBPWH White L



Stop Watch Golf Time Tennis All Score

## Scoreband Play

- Takes entry level scorekeeping technology to the next level.
- Scorekeeping modes: Golf, Tennis, All score.
- Time Mode.



- GASCBSPLAYB Blue
- GASCBSPLAYG Grey
- GASCBSPLAYP Pink

## Scoreband Scorer

- Able to keep score and statistics for golf or tennis.
- Water-resistant, eco-friendly silicone rubber.
- Slim comfortable design.
- Time Mode for on and off course use.
- 3 Button control means it's easy to use while playing.



- GASCBSBG3L Black/Green L
- GASCBSBWS2M White/Grey M
- GASCBSBWS3L White/Grey L



Golf



Allscore



Tennis

## Master Practice Cage Net

### PAPCMCN

- Multi-purpose net, usable for varied sports.
- Cage creates safe playing environment.
- Large size: 3 x 3 x 3 meters.
- High quality steel frame.
- Weight: 37 kg.
- Includes target : Size 78 x 75cm (high density polyester).

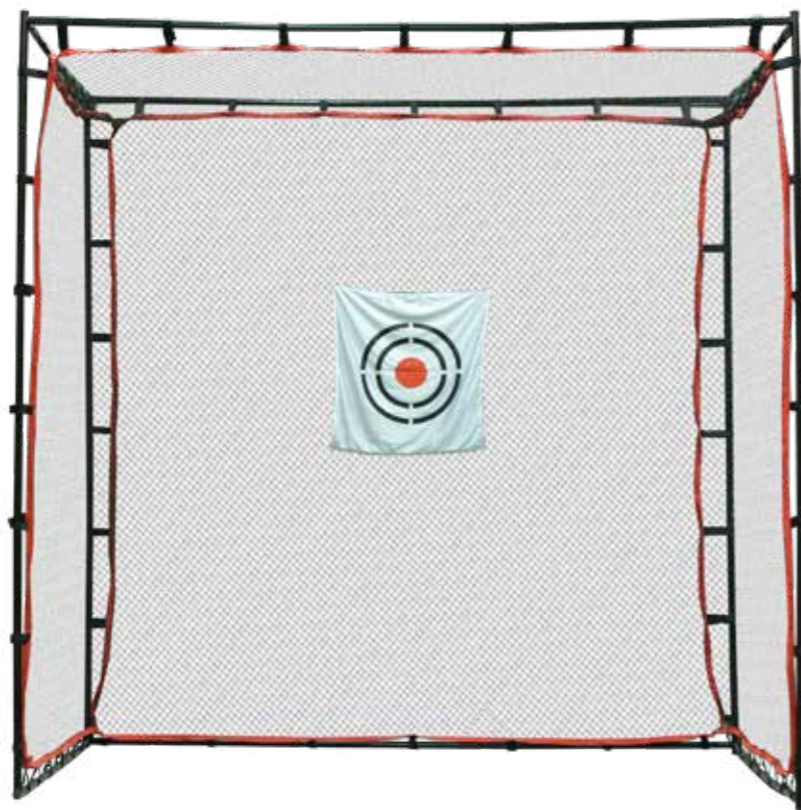

## Spare Net

### PAPCMNSN

## Baffle Net - 3m x 3m

### PAPCMCNB

- Additional back net recommended for heavy use.



## Net Repair Tie On Patch 30cm x 30cm

### PAPCMNPN



## Rain cover

### PAPCMRC



## Quad Driving Net

### PAPNQN

- Square shaped.
- Includes: Target, 4 pegs, carry bag.
- Ideal for golf club or garden.
- 60cm diameter. Target in the middle ideal for chipping practice.
- Easy to set up.
- 213w x 213h x 122d cm.
- Auto Ball return



Folds into compact carry bag



Automatically Returns Ball

**PROADVANCED™**  
be a Pro

## Pro Return Big Net

### PAPCPRN

- Automatic ball return feature sends ball back using patented net configuration technology.
- Lightweight, portable and includes durable carry case and ground stakes.
- Pops up in seconds, and folds instantly.
- High quality polyester net with steel frame.
- Extended size: 2.7 x 1.8m.
- Folded size: 79cm x 79cm x 8cm.
- Weight: 6.8 kg.



Folds into compact carry bag

## Super Sized Golf Practice Net

### PAPSNET

- Super sized mesh outdoor net, take a full swing with any club.
- Extra large surface target area.
- Ground sheet and Carry bag included.
- 300w x 272h x 180d cm.



## Colin Montgomerie Deluxe Golf Practice Net

### CMPAPCND

- Practice chipping, driving & iron play.
- Detachable 18 hole practice target.
- 305h x 213w x 151d cm.
- Carry bag included.

COLIN MONTGOMERIE 



## Pop Up Chipping Net

### PACNPNB

- Improves aim and distance.
- Can be used indoors and outdoors.
- Super fast set up, pops up in seconds.
- 53cm diameter.



## Colin Montgomerie Quad Chipping Net

### CMPACNSQ

- Unique square design.
- 5 Target pockets to catch shots.
- 65 X 67 x 70cm.

COLIN MONTGOMERIE 



## Cage Practice Net

### PAPCN

- Extra wide opening for ball capture.
- 305h x 213w x 151d cm.
- Detachable target.



## 4 in 1 Chipping Net

### PACN4

- 1 Standard basket with 3 smaller baskets.
- 3 Practice velcro practice balls.
- Indoor & outdoor use.
- 60cm diameter.



## Easy Net

### PAPNEN

- Support base included for indoor use.
- Shock-Corded Fibreglass frame.
- Perfect practice golf net.
- 274w x 213h cm.
- Detachable target included.

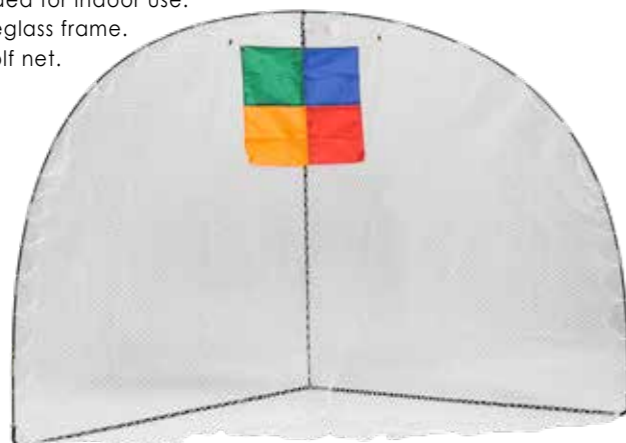

## Birdee Tailgate

### PABDT

- Perfect for chipping practice.
- Includes: 1 net, 6 birdees, 1 strike mat and carry bag.
- Birdees fly 9m at full swing
- Great for back yard on indoor use.
- Quick and easy to set up.
- Net size: 3m.
- Weight: 4.0 kg.

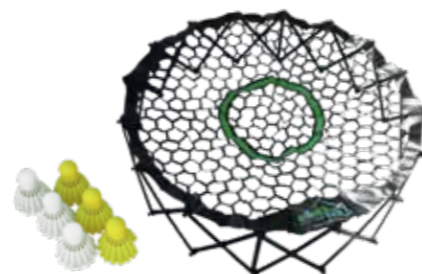

## Pro Chipping Net PROADVANCED<sup>®</sup>

### PACNPCN

- Practice anytime, anywhere.
- Unique pop-up design.
- Bottom pocket for stability.
- Angled target.



**Portable Golf Launch Mat**  
**PAPMLP**

- Portable for use indoor or outdoor.
- Realistic surface simulates hitting from the fairway.
- No divots - Protect your lawn or floor.
- Durable rubber backing.
- Dimensions: 20 x 41 x 2 cm.
- Includes adjustable height tee.
- \*Golf balls not included.



**Chipping Pro Mat**  
**PACP**

**New 2018**

- Simple and Easy to Use
- Teaches how to chip
- Get Instant Feedback
- Use with any wedge
- Inside or Outside
- Aids Alignment
- Fits in your Golf / Work Bag



\*Golf balls not included.

**Chip & Drive Practice Mat**

**PAPM12D 61 x 31cm**  
**PAPM34D 92 x 122cm**

- Quality turfed heavy duty mat.
- Includes rubber tee.

\*Golf balls not included.



**Colin Montgomerie Dual Practice Mat**  
**CMPAPM2D**

- Heavy duty 3-in-1 practice mat.
- Practice anytime, anywhere.
- Regular and extra long grass for realism.
- True feel in different lies. Includes rubber tee.
- 62.5 x 33.5cm.

\*Golf balls not included.

COLIN MONTGOMERIE



**Deluxe Practice Mat**  
**PAPM6D**

- Synthetic surface simulates natural grass.
- Includes hazards to catch missed shots.
- Easy to store.
- Raised putting hole.
- 183 x 30cm.



**ProAdvanced Infinity Green Putting Mat**

**PAPMPINF**

- 4 SPEED MAT WITH VISIBLE BALL TRACES.
- The ProInfinity Putting Mat is the ultimate premium mat simulating actual putting greens.
- 6 movable foam wedges.
- Life size silicon cup for quiet putting.
- Eraser Rod for easy ball trace removal.
- Every putt can be analysed and reproduced due to the mat's tracing technology.
- Training book with exercises and games.
- Size: 10ft x 20 inches (3m x 50cm).
- The 4 speeds vary from 8 (typical green speeds) to 12.5 (master tournament green speeds)
- The speed depends on whether the polyester fibres have been brushed high or flat with the supplied mat roller.
- You can putt in the fibre direction or against it.

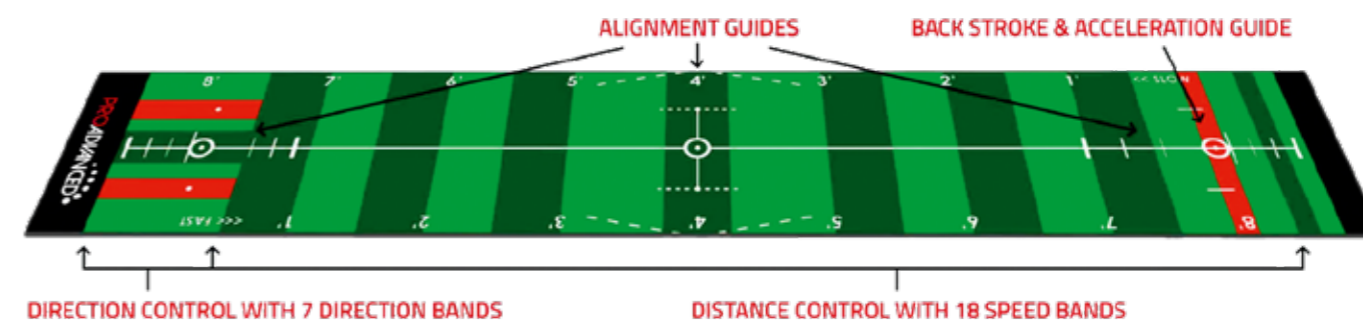
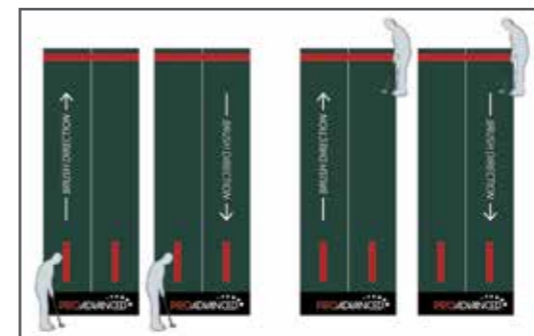

**Par 3 Deluxe Putting Green**

**New 2018**

**PAPMPAR3**

- High quality synthetic surface simulates natural grass feel
- Includes hazards for missed shots.
- Easy to store away.
- Dimensions: 274 x 91 cm.

\*Golf balls not included.

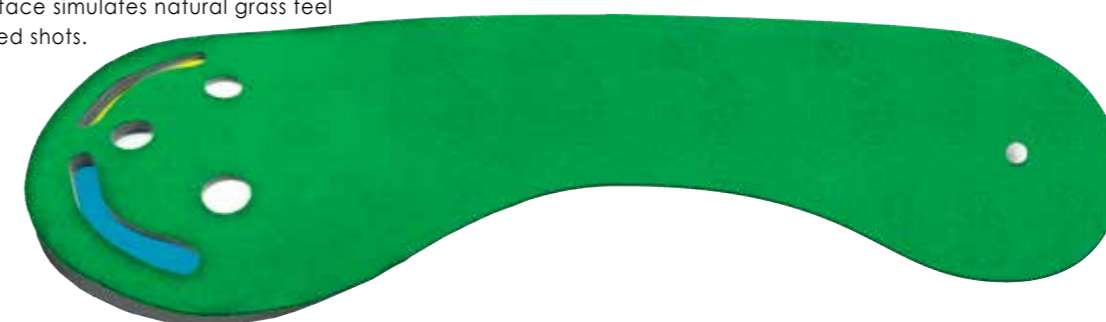

**Putt 'N' Hazard Putting Mat**

**PAPMH**

- Synthetic surface simulates natural grass feel.
- Includes bunker & water hazards.
- Recessed putting cup.
- Ball return tray.
- 200 x 35cm.

\*Golf balls not included.



## Welling Putt Putting Mats

- Includes training book with 54 exercises and 3 scorecard booklets.

Welling putt has been designed based on the theories of Alain Berthoz who advanced the hypothesis that: "The Memory of space in fact calls on a memory of movement, this being based on body movements associated with visual points of reference".

A good putt is the result of a good aim and the right speed. This is why we have designed welling-putt® with two directions of play

### Aim

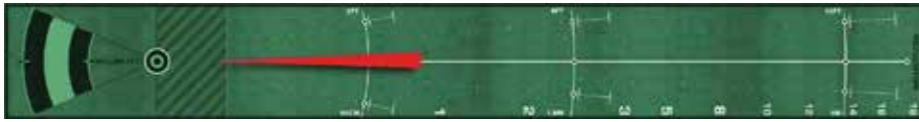

### Feeling



### The concept of the Welling putt mat

For the first time ever, you will have to pass the hole and finish behind in the "welling putt zone" or the "good putt zone"



#### "Good Putt" Zone

It is a proven fact that a putt that has the strength of strike to finish in a zone between 1ft and 2ft behind the hole has a better resistance to slopes, and therefore more chance of actually going down the hole.



#### Up Putt Zone

For experienced golfers, the "Up putt zone" will develop their offensive aspect, whilst ensuring the return putt.



#### Down Putt Zone

Similarly to the Up putt zone, the Down putt zone will develop a player's fine sensitivity, whilst ensuring the return putt.

### Tools for alignment and length

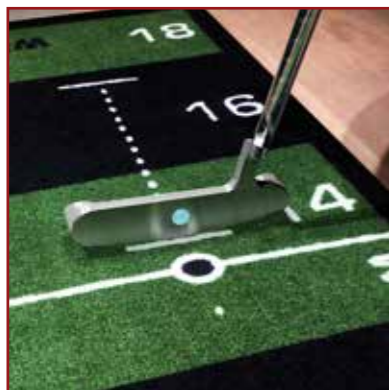

#### Alignment line for the putter face

Will help you aim your body by matching the putter face.

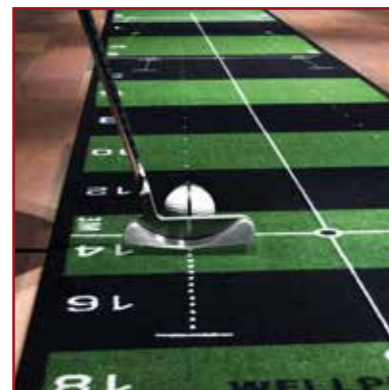

#### Alignment line

For the direction you are hitting towards.

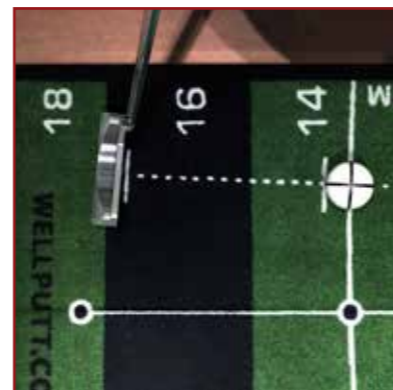

#### Necessary length of the stroke

To get through the ball with the right speed.



Patented Product:  
2585180

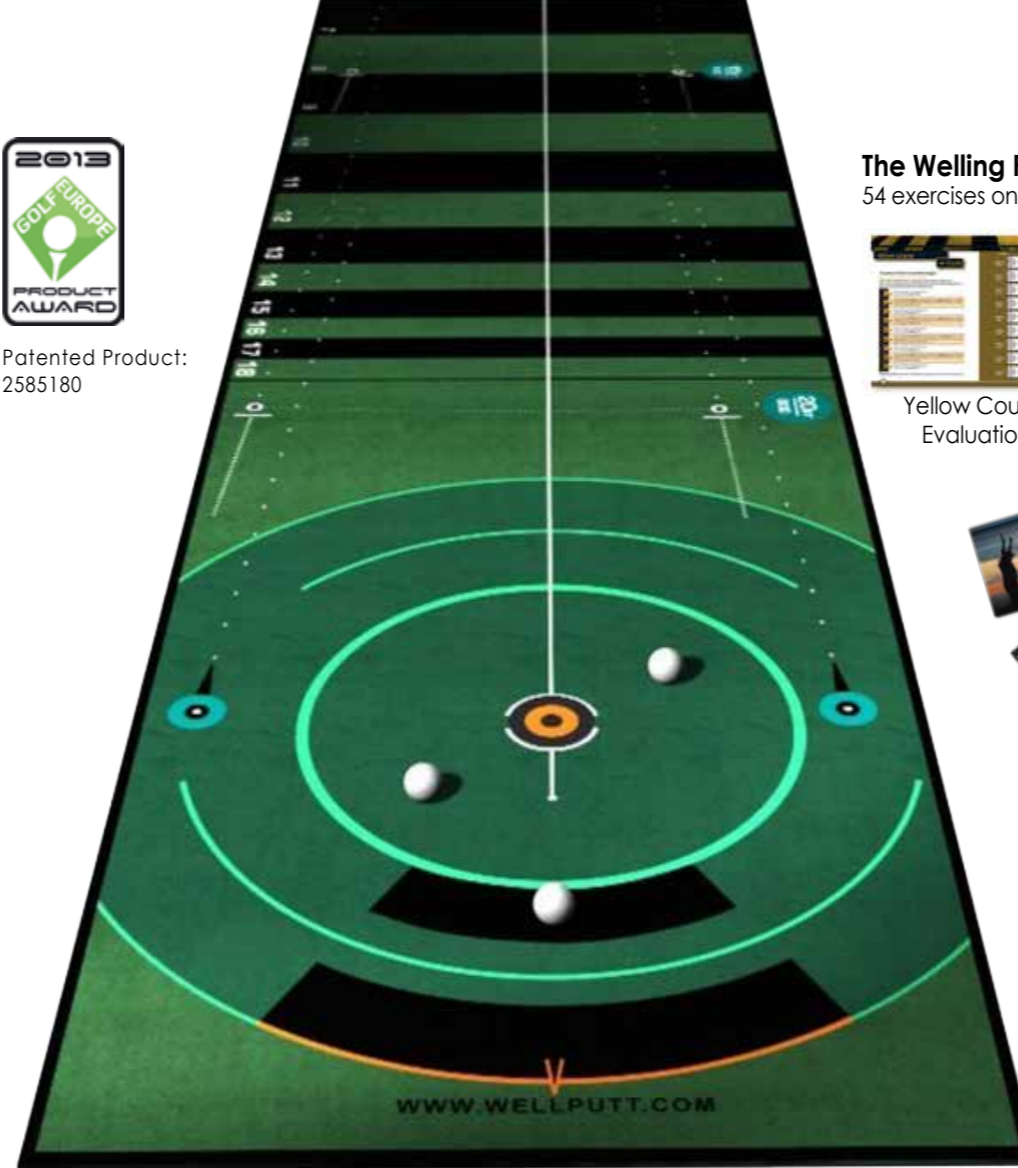

\*Golf balls not included.

MAT LENGTH	SPEED	
	PRO	STD
3M	●	●
4M	●	●
5M	●	
8M	●	

Pro Mats:  
Roll Speed 11ft/3.2m

Standard Mats:  
Roll Speed 9ft/2.8m

### The Welling Putt Mat Courses

54 exercises on 3 different courses (Evaluation, Confirmed, Professional).



Yellow Course  
Evaluation



Blue Course  
Confirmed



Black Course  
Professional



### 8m Pro Speed

PAPMW8  
Speed 11ft  
8m x 0.95m

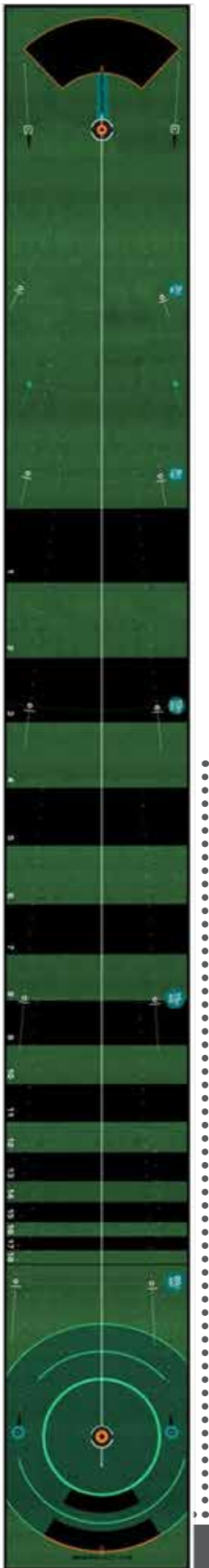

### 5m Ultimate Fitting Mat

PAPMW5  
Speed 11ft

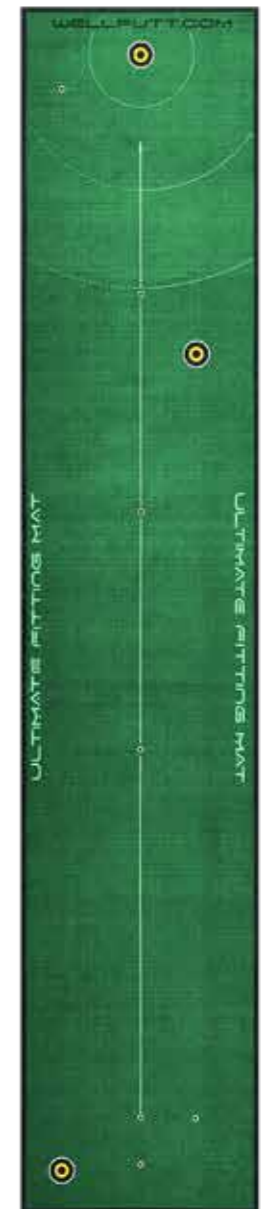

### 4m Pro Speed

PAPMW4  
Speed 11ft



### 4m Standard Speed

PAPMW4S  
Speed 9ft



### 3m Pro Speed

PAPMW3  
Speed 11ft



3m x 0.5m

### 3m Standard Speed

PAPMW3S  
Speed 9ft



3m x 0.5m

4m x 0.5m

4m x 0.5m

5m x 0.95m



## Welling Putt Arc to Arc Putting Guide

- PAPMWAAS**  
Arc to Arc Mat Standard
- PAPMWAAL**  
Arc to Arc Mat Light
- PAPMWAASQ**  
Arc to Arc Mat Square

- First flexible putting board on the market.
- Compact and easy to store in golf bag.
- Use indoors with Welling-putt mat or outdoors on putting green.
- Size: 79 x 17.8cm.

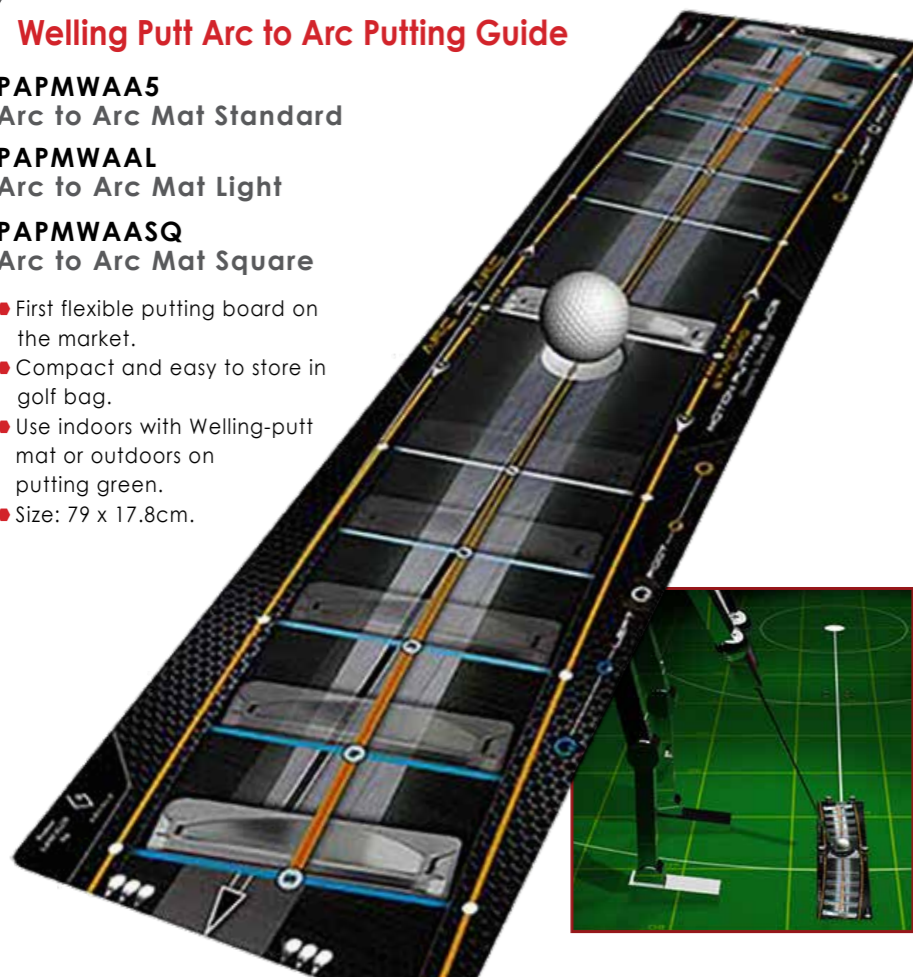

## Welling Putt Display Stand

PAPMWSPOS

- 110x50x45cm / 43"x20"x18"
- Contents include:  
4 x WellPutt Mat  
9 x Arc to Arc  
6 x Wellstance  
6 x Arc Weights.



## Welling Putt Standard POS

PAPMWPOS

- 170x76 / 67"x 30"
- Contents include:  
18 x WellPutt Mat  
18 x Arc to Arc  
5 x Wellstance  
5 x Arc Weights.
- Full HD TV with dynamic product presentation (movie)



## 4pk Arc Weights

PAPMWAASW

- Place on Arc to Arc.
- Will keep board firmly in place and can be used to increase or decrease width.



## Welling Putt Wellstance

- Develop your swing by being perfectly lined up on your target.
- Efficiency to gain in power and precision.
- Easy to use for golfers of all game levels.
- Length: 2ft 3", Width: 1ft.
- Weight: 21oz.
- Rapidly becomes an essential tool for weekly practice sessions.
- Includes Storage Bag.
- Available in Right Hand & Left Hand.

Wellstance aims to rapidly improve your swing, by insisting on the fundamentals (position, shoulder alignment, width of stance). Place on grass or mat driving practices.

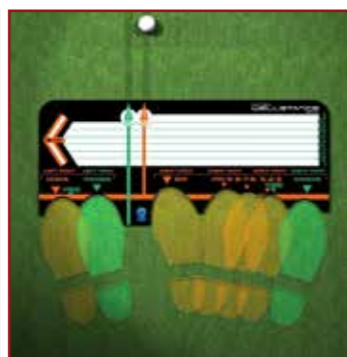

PAPMWS  
Right Hand



PAPMWSLH  
Left Hand

## Big Cup - FASTER PLAY LOWER SCORES MORE FUN!

PABCG Green

- Doubles the size of the hole to 9".
- Makes the hole seem 12ft to 15ft closer than traditional hole.
- Use indoor or outdoor
- Low cost investment for golf clubs.
- Great for Junior Golf.
- Corporate outing.
- Charity golf days ( custom Logo ring label available).
- Family golf.
- 7 Days post aerification.

Custom Logo available

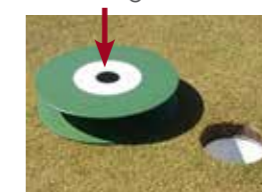

The Big Cup is the perfect way to add fast events at your course without damaging the green or adding maintenance expense. It's a 9" putting cup that sits on the green over existing putting cup and is fixed in place by a flag stick. NO expensive extra equipment, and NO HOLE CUTTING!



**PUTT FAST OR SLOW  
BIG CUP WILL CATCH THE BALL.**



## Hole In One Putting Cup

PAPCM  
Green

- Metal putting cup with flocking.
- Putt from any direction.
- Practice anytime, anywhere.



## Plastic Putting Cup

PAPCPP  
Pink

- Home & office Use.
- Includes flag.



## Swing Trainer

PASGT

- Swing trainer with ball & 4 pegs.
- Packed in colour box.



## Flagstick With Putting Cup

PAFS

- Have a green in your garden.
- Improve your short game.

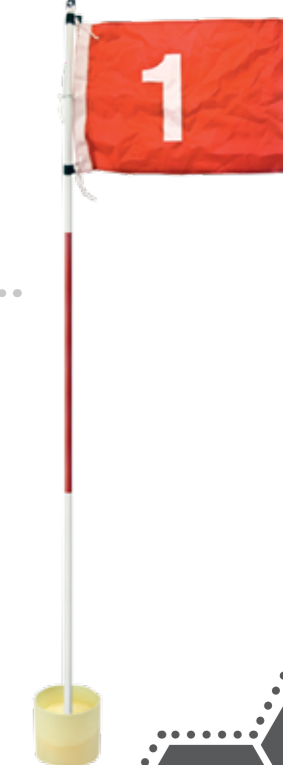

## Gorilla Gold Grip Enhancer

GAGE Single pk

- Grips even in heavy rain.
- Prevents over-gripping.
- USGA & R&A approved



## Target Tape

PATT

- Records impact point of your golf ball.
- Review the positioning of the club head in order to improve your game.
- Greater Distance & improved accuracy.



## 6pk Multi-coloured Foam Practice Balls

### PAFBM6 Multi-Colour

- Simulates the flight of a real ball.
- Soft practice balls with limited flight.
- Safe for indoor and outdoor use.



## 6pk Yellow Foam Practice Balls

### PAFB Yellow

- Simulates the flight of a real ball.
- Soft practice balls with limited flight.
- Safe for indoor and outdoor use.



## White Airflow Practice Balls

### PAAFW 6pk PAAFW12 12pk

- Perfect for practicing drives.
- Air holes maximise drag to limit distance.
- Simulates the flight of a real ball.



## 6pk Yellow Airflow Practice Balls

### PAAFY Yellow

- Perfect for practicing drives.
- Air holes maximise drag to limit distance.
- Simulates the flight of a real ball.



## 6pk Jelly Practice Balls

### PAPBJ6 Orange

- Soft feel practice ball.
- Safe to practice indoors or out.



## 6pk 30% Distance Practice Balls

### PAPB30Y Yellow

- 6 Yellow distance practice balls.
- Travels 30% of normal ball.



## 32pk Practice Golf Balls

### PAPBM32 20 White Airflow/ 12 Yellow Foam

- Practice ball pack in mesh bag with velcro sealed pockets.
- 20 white plastic airflow balls.
- 12 yellow foam balls.



**Airflow: 20 Balls included**



**Foam: 12 Balls included**



## David Leadbetter Training Grip

### GRMETL

- Finger pads & fins to guide grip.
- Approved by David Leadbetter.



## Golf Grip Training Aid

### GRGGM

- Prevents: Re-gripping, Hooking, Slicing.
- Provides: Discreetness, Uniqueness, Assurance.
- Promotes: Muscle Memory, Accuracy & Alignment, Distance & Control.
- Easy to fit & remove.



The golf-grip™ is a small pocket friendly product that allows the Golfer to achieve the perfect grip position. It is a unique tool that can be used on any club in the Golfers' bag. Consistent use is found to promote 'muscle memory' allowing the Golfer, with practice and time, to achieve the perfect grip - without assistance.

## Power Band

### PAPB

- Improves swing.
- Eradicates hooks or slices.
- Maintains connection throughout swing.
- Increases drive length.



## Grip-It Rite

- Checks, corrects & re-enforces a correct grip.
- Precision, finger & hand placement.
- Use it on your clubs for practice & play.
- Easy to fit & remove.



## Swing Ring

### PASR

- Weighted ring, ideal for warm up.
- Helps loosen muscles and increase swing speed.
- Slide over grip and down shaft.



## Chip Click

### PACC

- Audible 'Click' feedback.
- Straps to leading wrist around wrist joint.
- When chipping, wrist is kept straight.
- If wrist bends, it clicks to warn of incorrect swing action.



## I Gotcha Ready Warm-up System

- Ultimate first tee warm-up system.
- Works with any club in your bag.
- Simple three-step process to help establish a smooth tempo and powerful release.
- Quick and easy twist-n-lock design.
- Increases flexibility and warms up golf muscles.
- Same warm-up as hitting a bucket of range balls but only takes a minute.
- Available in - 8oz and 6oz.

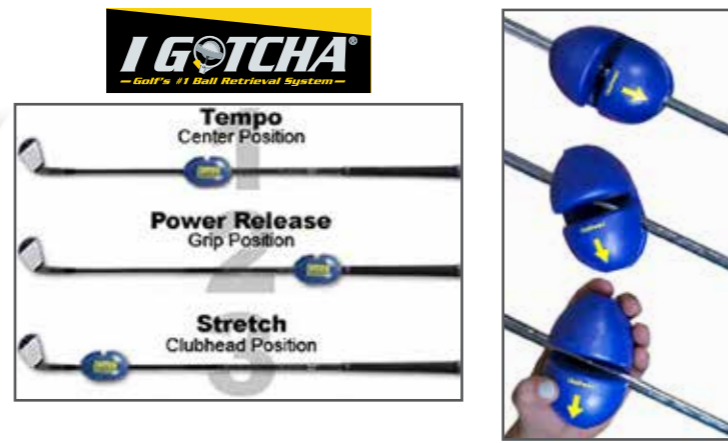

**PAIGWSM**  
Blue - 8oz for  
Swing Speed over  
100 MPH

**PAIGWSL**  
Ladys Pink

**PAIGWS6** **New 2018**  
Red - 6oz for Swing  
Speed under 100  
MPH

## Smash Bag

### PATSB

- Develops upper body strength and muscle memory.
- Provides feedback and accuracy at impact.
- Teaches feel of correct impact.



## Tour Mirror Training Aid

### PAEPM

- Provides full view of stroke, including eyes, shoulders and putter face.
- Placement slots including: ball gate and tee arrangement.
- Convenient and easy to use.
- Can be used indoors or out.
- 30x14.5cm



Shot alignment guides

## Tempo Trainer

### PAGSTT

- Teaches feel of correct impact.
- Provides feedback and accuracy at impact.
- Develops upper body strength and muscle memory.
- Size: 106 x 8cm.
- Weight: 1500g.



## Mini Mirror Training Aid **New 2018**

### PAMPM

- Provides full view of stroke, including eyes, shoulders and putter face.
- Placement slots including: ball gate and tee arrangement.
- Convenient and easy to use.
- Can be used indoors or out.
- 10x14cm



Shot alignment guides

## Tour Rodz Alignment Sticks

- PATRODW White
- PATRODY Yellow
- PATRODO Orange
- PATRODB Black

- Great for developing accuracy and feel.
- Improves your short game.
- Gain balance, rhythm and power.
- Use training booklet & get a perfect swing.
- Includes 2 x 44" Rods in PVC tube.



Includes Connectors



## T-Bar Compact Alignment Aid

### PATBA

- Extendable.
- Versatile training aid.
- Check stance, alignment, ball position and putting.
- Easy open/close folding system.

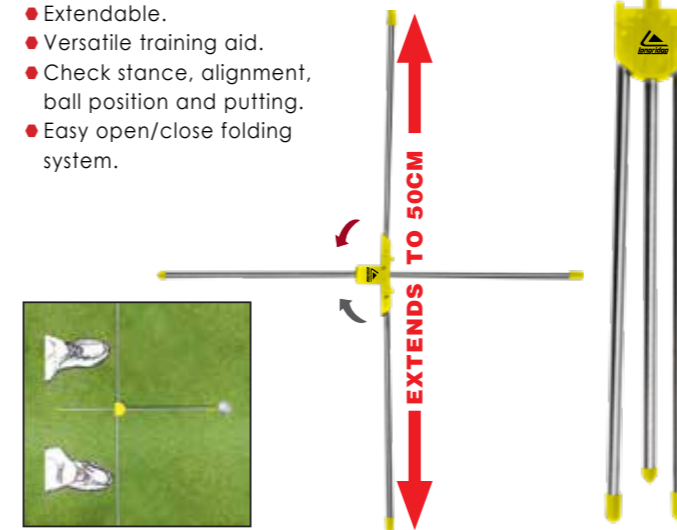

## Portable Tour Rodz Alignment Sticks

### PATRODPBS Black/Silver

- Portable and lightweight.
- Easy to carry in your golf bag.
- Multi-functional golf training aid.
- Contains 2 x 48" rods.
- Packed in PVC tube: 37cm x 3.5cm.

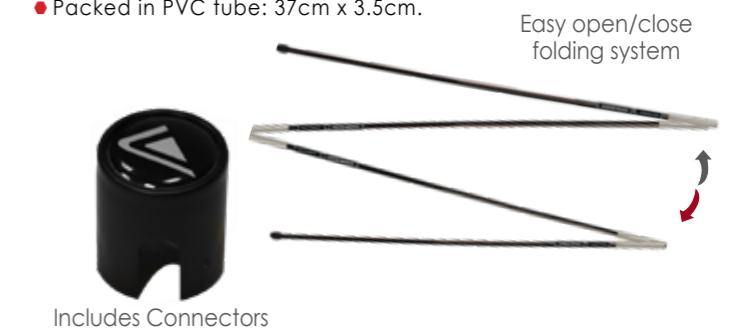

Includes Connectors

## Colin Montgomerie Alignment Sticks

### ○ CMPATRODW White

- Can be configured in multiple ways.
- Versatile training aid.
- Check stance, alignment, ball position and putting.



Set includes:  
2 x 44" rods,  
1 x 22" rod,  
2 x connectors  
Training booklet.



The tube lid doubles as an alignment system helping you learn to set up squarely, as well as hit draws and fades.

## Eze Ball Pick-up

### GABPND

- Ingenious design to pick golf balls from the green.
- Quick trigger opening.
- Easy to attach.



Easily attaches to grip



Quick release ball claw

## Pro Lite Ball Retriever

### BRTIPLR

- Ultra-Lite Golf Ball Retriever.
- Compact Size 42cm, Extends 2.7m.
- Fits easily in side pocket of most golf bags.
- Lightweight carbon fibre construction.
- Weight: 200 grams.



Push button 'Flick-open'



Swing & scoop up the ball



Patented design holds ball in place



## Ball Pick Up

### GABP Yellow

- Fits most putter grips.
- Easy to use.



## Deluxe Ball Pick Up

### GABPD Black

- Fits most putter grips.
- Easy to use.



## Ball Retrievers

### BR12 293cm Reach

### BR15 385cm Reach

### BR18 521cm Reach

- Rescue your golf ball.
- Telescopic, lightweight and easy to store.

### BR9B 201cm Reach

- Value ball retriever.



\* Value retriever

## Antenna Ball Retriever

### BRA Extends 2m

- Lightweight and telescopic, extends to 3m.
- Retracts to 40cm & will easily fit in golf bag side pocket.
- Grabs in water, sand, rough and ditches.



## Mini Ball Pick Up

New 2018

### GABPS Black

- Easily retrieves golf ball from the cup
- Attaches to the end of your putter grip
- Easy to install screw-in design
- No bending = Less strain on your back



## Executive Ball Retriever

### BREXBR

- Size: 15ft x 450cm.
- Comes with a dual zip headcover.
- Ergonomic grip handle.
- Stainless steel retriever mechanism.



## I gotcha Stainless Steel Compact Ball Retrievers

### BRIGCE10 10ft Executive

### BRIGCX14 14ft XL

### BRIGCU18 18ft Ultimate XL

- Super-sturdy and durable stainless steel shaft.
- Patent pending locking clip.
- Ultra-compact design to store in golf bag, collapsing to less than 21 inches.
- Available in three sizes:
- Executive - 10ft. reach, most compact, collapses to 15.5 inches and weighs only 8oz.
- XL - 14ft. reach, best-selling model.
- Ultimate XL - 18ft. reach, only 3.5 inches longer than the Executive, yet extends 4ft longer.



## I Gotcha Counter Display Unit

### STANDIG

- Holds 18 I Gotcha Compact Ball Retrievers.



## I Gotcha Aluminium Ball Retrievers

### BRIG18 18ft Standard

### BRIG21 21ft Biggest

- Sturdy and durable aluminium shaft.
- Twist and lock shaft.
- Patent pending locking clip.
- Available in two sizes: Standard - 18ft. reach. Biggest - 21ft. reach.



**LIFETIME WARRANTY WITH ALL I GOTCHA BALL RETRIEVER HEADS**  
CONTACT US FOR MORE DETAILS

## Search & Rescue New 2018

### BRSR10 10ft

### BRSR14 14ft

### BRSR18 18ft

- Patented Magic Gripper head is magnetic-like, gripping a golf ball like magic on any surface
- The anodized aluminium head, prevents oxidation and corrosion; No moving parts reduces any chance of breakage

IGOTCHA's unique ball retriever design is simple to use:

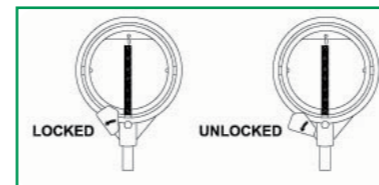

Unlock the yellow Locking Clip.



Reach out for the ball, placing the 'ready' head over the ball as shown.

## The #1 Training Aid in Golf

The Medicus® DualHinge™ is the most successful and effective golf training aid in the World. Learn to swing on path and control your clubface to truly start hitting consistent, on-target shots with the new DualHinge™ D.A. Driver or any of the other products that make up the entire DualHinge™ club line.

**MEDICUS**



**DualHinge™**

White line shows target line and clubface address position

Arrows indicate swing path

Blue line shows target line and clubface impact position

### Dual Handle

PAMDPT

- Master The Perfect Putting Stroke
- Reduce the number of strokes you take on the green
- Promotes dominant shoulder movement, creating a smooth putting stroke for ultimate control. Can attach easily to any putter
- Shows golfers the flat wrists necessary to reduce strokes and make putts



Dual Hinge

### Medicus Dual Hinge 460cc Driver

PAMHD 460cc



Also available as #5 and #7 irons

### Medicus Dual Hinge #5 Iron

PAMH5 5 Iron



### Medicus Dual Hinge #7 Iron

PAMH7 7 Iron



### Deluxe Shag Bag

PASBD

- Quick ball collection after practice.
- Pick up balls easily without bending.
- 2 Piece design with metal tube.
- Holds up to 75 balls.
- Strong durable construction.



### Collapsible Shag Bag

PASBC

- Collect balls without bending.
- Holds up to 100 balls.
- Strong durable construction.
- Telescopic aluminium tube.



TELESCOPIC

### Clikka Tube

PACTN Red/White

PACTA Aluminium

- Ingenious design to collect golf balls.
- Quickly pick up loose balls after practice.
- Stores 21 balls.



\* Quick ball release trigger

### Grip & Swing Trainer

PAST

- Weighted head for improved muscle memory.
- Fitted with moulded training grip.
- Adjustable weight.



### Round Scorer

GASR



### Pencil

GAPE288 288 pcs



### 18 Hole Scorer

GA18



### Pencil & Eraser

GAPER288 288 pcs



### 2 Player Stroke Counter

GAPSP2



### Bead Stroke Counter

GABC Black/White

GABCRW Red/White



**Deluxe Scorecard Holder**

- GASCDL Blue
- GASCDPK Pink
- GASCDR Red
- GASCDK Black



**Executive Scorecard Holder**  
GASCLE



**Scorecard Holder**  
GASC



**Water Bottle Club Cleaner**  
CAWB



**2 Way Brush & Keyring**  
CA2W



**Groove Bush Pro**  
CAGBP



**Champ Dual Golf Brush 2 & Zip Line**  
SACHADBZ

- Comfortable grip.
- Deep sweep action to clean all spikes.
- Removes grass & sand with ease.

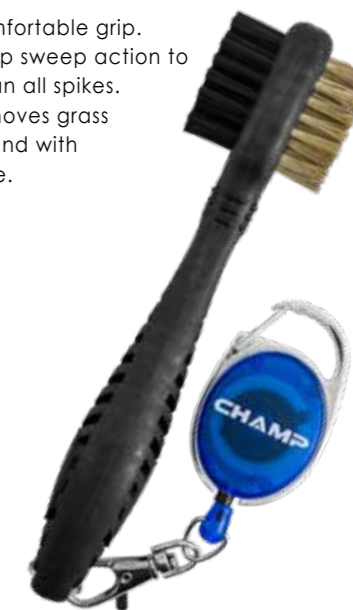

**Tee Holder**

GATB

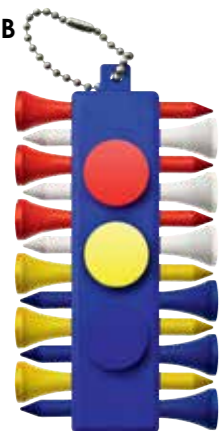

**Ball Alignment & Sharpie Marker**  
GABLD



**Ball I.D. Stencil & Line-up Kit**  
GABLD



Mark golf ball for easy identification



**70pc Sharpie Mini Marker Tub**  
GABMDM72



**Sharpie Mini Markers**  
GABMDM4  
4 Colours



**Sharpie Twin Tip Marker**  
GABMDMT Black



**Neoprene Ball Holder**  
BABS



**Pocket Ball Washer**  
CAPBWM



**4-in-1 Tool**  
GA41



**3-in-1 Cleaner & Clip**  
CA31C



**3-in-1 Cleaner**  
CA3148  
48pc display



**GET INTO THE GROOVE**

GrooVtec



**GrooVtec Multi-Pin Cleaner**

- GAGTN Blue
- GAGTY Yellow
- GAGTLW White
- GAGTG Green

- Eight pins allow grooves to be cleaned simultaneously.
- Cleans to base of grooves.
- Cleaning pins fit most irons, angle pins to fit if necessary.
- Includes a ball marker which can be personalised.
- Available in four eye-catching colours.
- Includes belt/bag clip with elasticated reel.
- GrooVtec is protected by a Registered Community Design No. 001754748.

**GrooVtec Groove Blade**

GAGTGRS

- Lower your handicap with cleaner, sharper and well maintained grooves.
- Generate more spin on the green.
- Made from the hardest tool steel the groove tool is guaranteed for life.
- Put new life back into your short game with groove tool.

**Groove Sharpener tool with 6 heads**  
CAGX6 New 2018

- Puts life back into tired wedges and irons.
- 6 sharpening heads mean whatever the make of your clubs, this groove sharpener will work for you.

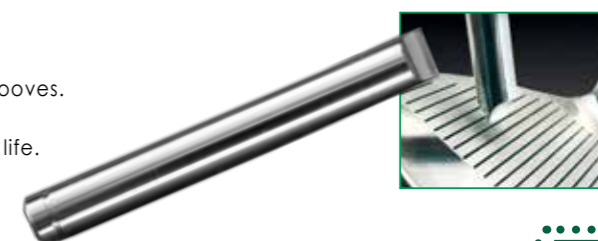

**Eze Auto Pitchfork**



\* Flick action retractable pitch fork with ball marker

**FULL HOUSE POKER CHIP BALL MARKERS**

MANY FUN DESIGNS  
BALL LINE UP ON BACK OF CHIP  
INCLUDES DISPLAY CASE



Includes free counter top display

**Novelty Poker Chip Ballmarkers 80pc Set**  
GABMPO80

Ball line up on the reverse side

**Promo Silver Pitchfork**  
GAPMES

**Apex Pitchfork**  
GAPFARS

**Vector Pitchfork**  
GAPFB

**Pitchfork Blister Packed**  
GAPFBB

**Laurel Pitchfork & Clip**  
GAPMCSL



All pitchfork come with removable ball marker

**Plastic Pitchfork - 200pcs**

- ● ● ○ **GAPMP2 Assorted Colours**
- **GAPMP2W White**



**Metal Pitchfork**  
GAPMM1 100 pcs



**Keep Calm Pokerchip Ball Markers 2pk**  
GABMPCYW



**Poker Chip with Removable Magnetic Ball Marker**

- ○ **GABMOMBK Black/White**
- ○ **GABMOMRD Red/White**
- ○ **GABMOMBL Blue/White**



**Plain Poker Chip with Removable Cap Clip & Ball Marker Magnetic Ball Marker**

- **GABMOBL Blue**
- **GABMOGR Green**
- **GABMORD Red**
- **GABMOBK Black**
- **GABMOWH White**



**New 2018 GACCPSL Loose**

**Deluxe Cap Clip & Ball Marker**

- **GACCS Silver**
- **GACC Bronze**



Inside Diameter 23.5mm

**Fizgolf Divot Tool**

**GAFIDT**  
● Ball washer



**OFFER**

**FREE WITH ANY 100 PCS LOGO ORDER**

**Ball Marker & Pitchfork Display**  
GAAPFBMD



**50pk Novelty Assorted Ball Markers**  
GABMSF5 Flat / 50 pcs

Available Individually

1. GABMNDOL
2. GABMNS66
3. GABNNSHA
4. GABMNENG
5. GABMNIRE
6. GABMNSCO
7. GABMNWAL



**Blank Metal Ball Markers**  
GABMSF5P Flat/50 pk  
GABMSS5P Stud/50 pk



21.5mm Inside Diameter  
25mm Outside Diameter

Magnetic

**Plastic Ball Marker**  
GABMP2 Assorted 200 pcs  
GABMPI2 Pink 200pcs



## Colin Montgomerie Towel Pouch

### CMGGTTP Black

- Golf towel with hanging clip.
- Protective wrap.
- Glove holder pad.
- 6 Tees.



COLIN MONTGOMERIE

## Clicgear Towel

### TRCCACAGT3B Black

- Made to attach to your cart.
- Easy snap clip.
- Cleaning pad for polishing your clubs.



Polishing pad for your clubs



Made to attach to cart



## Devant Arctic Blast Cooling Towel

Beat the heat with Devant's NEW Arctic Blast quick cooling towel. The activated towel can cool to 30 degrees below ambient temperature providing an instant cooling effect on the neck, head or other hot spots. The performance fabric will provide UPF 45+ protection when covering the skin.

- Lightweight, chemical free.
- Keep cool during indoor and outdoor activities.
- Fabric can cool down to 30 degrees below ambient temperature.
- The performance fabric will instantly cool when wet with water, wrung out and snapped in the air to activate the cooling technology.
- The cooling towel provides UPF 45 protection when covering the skin.
- Dries soft.
- Measures: 92 x 31cm unfolded.
- Made of 80% polyester and 20% nylon.
- Comes packaged in a plastic container.
- Can be customized with your logo or image of your choice.

- CAGTABBK Black
- CAGTABRD Red
- CAGTABRL Royal
- CAGTABWH White

# BEAT THE HEAT IN 3 EASY STEPS

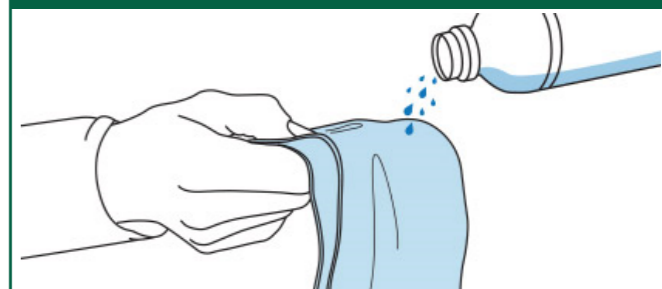

## STEP 1. Get it wet with water



## STEP 2. Wring out excess water

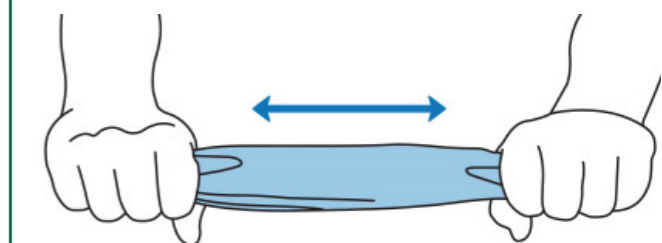

## STEP 3. Snap to activate cooling

## Luxury Two Fold Towel

### CAGT2B Black

- Mesh pocket for balls and tees.
- Measures 19 x 59cm folded.
- Ideal for embroidered logo.
- Header card packed.



Pocket for balls, tees & accessories



## Tri Fold Luxury Towel

- 40cm x 50cm unfolded.
- 100% Cotton.
- 3 fold with grommet & hook.

- CAGT3LRD Red
- CAGT3LBL Blue
- CAGT3LGR Green
- CAGT3LBK Black
- CAGT3P Pink



## Black Three Fold Towel

### CAGT3B Black

- Clips to golf bags.
- Measures: 50 x 25cm unfolded, 50 x 8cm folded.
- Colour sleeve packed.



## Bag Towel & Brush Set

### CAGTBR Black

- Large size towel.
- Handy brush.
- Clips to golf bag.
- Measures 63.5 X 40cm unfolded.
- Header card packed.



Supplied in a plastic container



## BagBoy Telescopic Wind Vent Umbrella

- Umbrella extends 4" longer than standard umbrellas.
- Double vented canopy system to prevent inversion in high winds.
- 62" diameter for maximum coverage.
- Push button auto open.
- Provides protection from both rain/sunshine and does not conduct electricity.
- Non-slip ergonomic cushion grip.
- Reinforced fiberglass shaft, ribs and hub.
- Velcro® closure straps.



UMBBWVNW  
Navy/White



UMBBWVBW  
Black/White



UMBBWVRW  
Red/White



UMBBWVB  
Black



## BagBoy Telescopic UV Umbrella

- Umbrella extends 4" longer than standard umbrellas.
- Double vented canopy system to prevent inversion in high winds.
- 62" diameter for maximum coverage.
- Push button auto open.
- Provides protection from both rain/sunshine and does not conduct electricity.
- Non-slip ergonomic cushion grip.
- Reinforced fiberglass shaft, ribs and hub.
- Velcro® closure straps.



UMBBUVVVS  
Silver

## 62" Silverback UV Umbrella

- Protection rain or shine.
- Windproof with 62" arc span.
- Durable poly pongee material with UV protection silver lining.
- Blocks harmful UV rays.
- Fibreglass shaft and ribs.
- Rubber handle.



UMWPUVB  
Black/Silver

## 60" Dual Canopy Umbrella

- Double canopy construction allows wind to pass through and prevents the umbrella from inverting.
- Windproof with 60" arc span.
- Durable soft feel polypongee material.
- Fibreglass shaft/ribs & rubber handle.



UMWPP30NW  
Navy/White

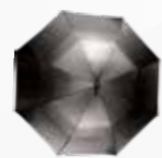

UMWPP30B  
Black

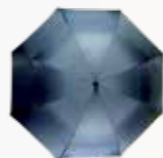

UMWPP30N  
Navy



UMWPP30BW  
Blue/White



UMWPP30BW  
Black/White



UMWPP30GW  
Green/White

# ECOVESSEL®

MODERNSTYLING PERFORMANCEDRIVEN



The Anatomy of Innovation Every Ideas Starts With An Original Concept

### Maximum Performance



- Our signature **TriMax Triple Insulation** hydration vessels have been independently tested to outperform our competitors.
- The superior conductive property of copper evenly maintains the temperature throughout the bottle, enhancing the insulation.
- **TriMax Triple Insulation** has been tested to keep drinks **COLD FOR 36 HOURS AND HOT UP TO 8 HOURS.**

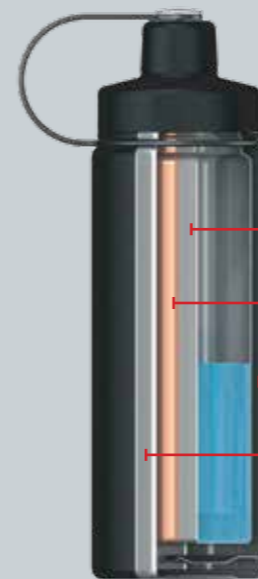

- Stainless Steel inner
- Copper inner
- Vacuum center
- Stainless Steel outer

### Highest Quality Materials

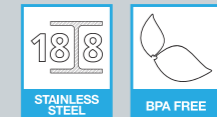

- The material we use meet or exceed FDA Standards, Consumer Product Safety Commission requirements, and strict European standards. Our products are BPA and phthalate free and are recyclable.

### Exceptional Customer Service



- We provide friendly, knowledgeable customer support and stand behind all of our products with our **100 YEARS WARRANTY.**

### Added Value and Versatility



Silicone Base for Soft Landing

Removable Strainer basket for loose tea, fruit or ice cubes



Fill infuser with fresh fruit to flavor water, tea, beer or wine



Part of EcoVessel's mission is to support Water For People, a long established non-profit, which helps provide permanent solutions to the water, sanitation, and hygiene conditions in developing countries.

EcoVessel founder, Jon Fox, while in Guatemala on a Water For People mission.



## The Boulder



- Triple Insulation for maximum performance
- Removable strainer for loose tea, fruit, ice.
- Fits most cup holders.
- Custom Logo available.



**36**  
HOURS  
COLD

**10**  
HOURS  
HOT

### 20oz/600ml

- **GGEVBO20BK** Black
- **GGEVBO20BL** Blue
- **GGEVBO20RD** Red
- **GGEVBO20SI** Silver

**40**  
HOURS  
COLD

**12**  
HOURS  
HOT

### 24oz/700ml

- **GGEVBO24BK** Black
- **GGEVBO24RD** Red
- **GGEVBO24BL** Blue
- **GGEVBO24SI** Silver

## The Perk 20oz/600ml



- Triple Insulation for maximum performance
- Removable strainer for loose tea, fruit, ice.
- Condensation free so hands stay dry.
- Fits most cup holders.
- Push button open/lock lid.
- Custom Logo available.



- **GGEVPE20BK** Black
- **GGEVPE20BL** Blue
- **GGEVPE20PU** Purple
- **GGEVPE20SI** Silver

## The Metro 16oz/473ml



Silicone Base for Soft Landing



Tritan Slider Lid



- Triple Insulation for maximum performance
- Non-skid silicone base for soft landing.
- Condensation free so hands stay dry.
- Fits most cup holders.
- Custom Logo available.

- **GGEVME16BK** Black
- **GGEVME16BL** Blue
- **GGEVME16SI** Silver



## Boss Growler 64oz/1900ml

Small Mouth for Easy Drinking



- Triple Insulation for maximum performance
- Removable snap-in flavour infuser.
- Removable tea, fruit, ice strainer.
- Condensation free so hands stay dry.
- Custom Logo available.

Fill infuser with fresh fruit to flavor water, tea, beer or wine



- **GGEVBG64BK** Black
- **GGEVBG64SI** Silver



## Double Barrel 16oz/500ml



Slider Lid



- Double Wall Insulation.
- Use for hot and cold drinks.
- Easy clean, open/close slider lid.
- Condensation free so hands stay dry.
- Custom Logo available.

- **GGEVDB16CO** Copper

- **GGEVDB16SI** Silver



## The Port 10oz/296ml



Silicone Base for Soft Landing



- Triple Insulation for maximum performance.
- Non-skid silicone base for soft landing.
- Condensation free so hands stay dry.
- Easy clean drinking lid.
- Custom Logo available.

● **GGEVPO10GO** Gold ● **GGEVPO10BK** Black ● **GGEVPO10SI** Silver



Removable Lid



## The Aspen



Insulated Lid in Stainless Steel with Minimal Internal Threading

Silicone Base for Soft Landing



- Triple Insulation for maximum performance.
- Minimal internal threading for quick operating/closing.
- Top designed so drinks do not touch plastic.
- Smooth, hygienic, comfortable drinking rim.
- Non-skid silicone base for soft landing.
- Condensation free so hands stay dry.
- Ice cube and cup holder friendly.
- Custom Logo available.



**100 HOURS** COLD **20 HOURS** HOT

25oz/750ml

● **GGEVAS25BM** Blue  
● **GGEVAS25GS** Gray Smoke  
● **GGEVAS25RG** Rose Gold

**80 HOURS** COLD **16 HOURS** HOT

16oz/473ml

● **GGEVAS16BM** Blue  
● **GGEVAS16GS** Gray Smoke  
● **GGEVAS16GO** Gold  
● **GGEVAS16RG** Rose Gold  
● **GGEVAS16SI** Silver  
● **GGEVAS16PW** Pearl White

Custom Logo Available

Discover it on page 165



COLIN MONTGOMERIE



## THE COLIN MONTGOMERIE COLLECTION

Colin Montgomerie turned professional in 1987. In 1993 he became Europe's No.1, a position he retained for an unprecedented run of seven years. He achieved a record 8 European Order of Merit wins. Awarded an OBE in 2004. Captain of the winning 2010 European Ryder Cup team. Awarded the 2010 BBC Sports Personality Coach of the Year award.



### Executive Putting Set

#### CMGGEPS Right Hand

- Collapsible putter.
- 2 Golf balls.
- Metal putting cup.
- Leatherette case.
- Colour box.



### Scorer, Fork & Tees Gift Set

#### CMGGSSPT

- 18 Hole scorer.
- Pitchfork with ballmarker.
- 4 Silver wooden tees.
- Scores up to 4 players.
- Built-in clock.



### Digital Scorer

#### CMGAES4D

- 18 Hole scorer.
- Scores up to 4 players.
- Built-in clock.
- Shock resistant case.
- Bag attachment clip.



Multi-feature display

Official licensed products of Colin Montgomerie produced under license by JS International

### Digital Golf Distance Finder

**CMGADFD**

- High quality optics digital technology.
- Glare and scratch proof lens coating.
- Wrist strap.
- Case with belt loop.



### Golfers Hip flask Set

**CMGGHFD**

- Stainless steel.
- Hinged safety cap.
- 5 Tees.



### Deluxe Scorecard Holder Set

**CMGASCHD**

- Deluxe scorecard holder.
- Pitch fork with ballmarker.
- Metal pen.



### Accessory Bag with Scorecard

**CMGAABS**

- Quality faux leather look, stylish design.
- Scorecard upholstered sleeve.
- Pencil and 4 tees included.



### Mini Golf Bag Pen Set

**CMGGPHC**

- Luxury mini golf bag.
- In-built clock.
- Golf club shaped pens with grip covers.
- Driver/Red, Iron/Black, Putter/Blue.



Pen & grip lid

Clock

### Desk Golf Bag & Pen Set

**CMGGPHT**

- Perfect gift for any golfer.
- Mini folding golf trolley.
- Luxury removable golf bag.
- 3 Golf club pens (Red/Black/Blue).



Pen & grip lid

### Executive Shoe Bag

**CMGGSBCC**

- Executive shoe bag with accessories.
- High quality with vents & side pockets.
- Includes shoe cleaning brush with spike removable tool, cleaning cloth, polish and dual club brush.



### Towel Pouch

**CMGGTTPP Black**

- Golf towel with hanging clip.
- Protective wrap.
- Glove holder pad.
- 6 Tees.



### Golf Club Pen Set

**CMGGMGPS**

- Stainless steel pen set.
- Fun for desktop putting.
- 3 piece set contains:
  - 1 x black pen
  - 1 x blue pen
  - 1 x red pen.



Pen & grip lid

### Pro Feel Hybrid Glove

- Cabretta leather palm for feel
- Stretch lycra knuckle for superb fit
- Breathable synthetic back
- Durable long lasting performance
- Includes magnetic ballmarker



White	Mens	CMGLCADFW	S,M,ML,L,XL
White	Ladies	CMGLCADFLW	S,M,L

### Accessory Bag with Practice Balls & Tees

**CMPAPBT**

- Handy accessory bag.
- Clips easily to golf bag.
- Includes 12 practice balls and 30 tees.



### Water bottle & Tees Set

**CMGGWBT**  
100 x 69mm

- Water bottle
- 100 x 69mm Black and white tees.



### Pitchfork Keyring

**CMGGKCSGB**

- Inter-locking pitchfork.
- Can be reversed for use.
- Magnetic ballmarker.
- Includes key ring.



### Golf Divot Tool

**CMGAPFR**

- Push button retractable fork.
- Integrated ballmarker.



### Deluxe Golf Practice Net

**CMPAPCND**

- Practice chipping, driving & iron play.
- Detachable 18 hole practice target.
- 305h x 213w x 151d cm.
- Carry bag included.



### Golf Ball Monogrammer

**CMGABM**

- Personalises individual balls.
- Simple and easy to use.
- Ball not included.



### Silver Auto Putt Returner

**CMPAAPS**

- Returns ball automatically.
- Home & office use.
- Ball not included.
- Requires 2 x C1.5v batteries.



### Dual Practice Mat

**CMPAPM2D**

- Heavy duty 3-in1 practice mat.
- Practice anytime, anywhere.
- Regular and extra long grass for realism.
- True feel in different lies.
- Includes rubber tee.
- Ball not included.
- 62.5 x 33.5cm.



### Micro Ball Retriever

**CMBRAP**

- Compact & lightweight.
- High quality aluminium.
- Clips to your Golf bag.
- Extends 2m.



### Quad Chipping Net

**CMPACNSQ**

- Unique square design.
- 5 Target pockets to catch shots.
- 65 X 67 x 70cm.



### Alignment Sticks

**CMPATRODW**  
White

- Can be configured in multiple ways.
- Versatile training aid.
- Check stance, alignment, ball position and putting.



Set includes:  
2 x 44" rods,  
1 x 22" rod,  
2 x connectors  
Training booklet.



The tube lid doubles as an alignment system helping you learn to set up squarely, as well as hit draws and fades.



THE  
**OLD COURSE**  
St Andrews Links



THE  
**OLD COURSE**  
St Andrews Links

## St Andrews the Home of Golf

The game of golf as we know it today originated at what is now The Old Course at St Andrews Links. On this narrow strip of land extending out into the Eden Estuary from the ancient town of St Andrews, golf was first played more than 600 years ago.

### St Andrews Three Fold Towel

#WDCAT3G Green/One Size

- Three fold golf towel ideal for on the course.
- Ultra soft, high absorbency, easy wash and quick dry.
- The Old Course logo embroidered on front.
- Hook clip for hanging towel on golf bag.
- Material: 100% cotton.
- Dimensions:  
45cm x 14cm folded,  
45cm x 38cm open.



### St Andrews Cap

#WDHWCAP Green/One Size

- Perfect for sunny days on the course.
- Adjustable fabric strap with metal buckle.
- Beautifully embroidered Old Course logo.
- Made from 70% polyester, 30% cotton.



### St Andrews Whisky Tumbler & Hip Flask Set

#WDGGWTS

- Presented in a beautiful Old Course display box.
- The Old Course logo printed on tumbler and hip flask.
- Materials: Chunky glass (Tumbler), Black brushed metal (Hip flask).
- Tumbler dimensions: 8.2cm width, 8.5cm height
- Hip flask dimensions: 9.5cm width, 11cm height, 2cm depth.
- Hip Flask Capacity: 175ml (6 fl oz).
- Glass Capacity: 260ml (9 fl oz).



### St Andrews Golfers Beanie Hat

#WDHQBH Green/One Size

- Perfect for cold and winter days on the course.
- Knitted beanie hat with turn up design.
- Old Course logo stitched on front.
- Made from 100% acrylic.



### St Andrews Golfers Gift Set

#WDGGGS

- Perfect for the keen golfer
- Presented in a beautiful Old Course display box
- 10 piece Golfer's set includes:  
1 x Pitch fork with Ball Marker,  
2 Callaway golf balls,  
6 x wooden tees
- The Old Course logo printed on golf balls, ball marker and tees.





THE  
**OLD COURSE**  
St Andrews Links



THE  
**OLD COURSE**  
St Andrews Links

### St Andrews Notebook with Pen

#WDGGNP

- Hardback notebook and engraved ballpoint pen.
- The Old Course logo printed on notebook.
- Ribbon page marker with elasticated pen holder & strap.
- Size: A5 (w 14.8cm x h 21cm) with 120 lined pages - 100GSM.



### St Andrews Set of 4 Coasters

#WDGGCOST

- Set of 4 coasters detailing scenes of The Old Course.
- Wipe clean surface.
- Materials: MDF, Cork backed.
- Coaster size: 10.5cm x 10.5cm.



### St Andrews Swilcan Bridge Scene Mug

#WDGGMBRI

- The Old Course Swilcan Bridge scene wraparound.
- Material: Bone China.
- Capacity: 300ml (10.5 fl oz).
- Mug dimensions: 102mm width, 102mm height.
- Not dishwasher safe.



### St Andrews Old Course Mug

#WDGGMGRN

- The Old Course St. Andrews links logo.
- Material: Bone China.
- Capacity: 295ml (10 fl oz).
- Mug dimensions: 82mm width, 85mm height.
- Not dishwasher safe.

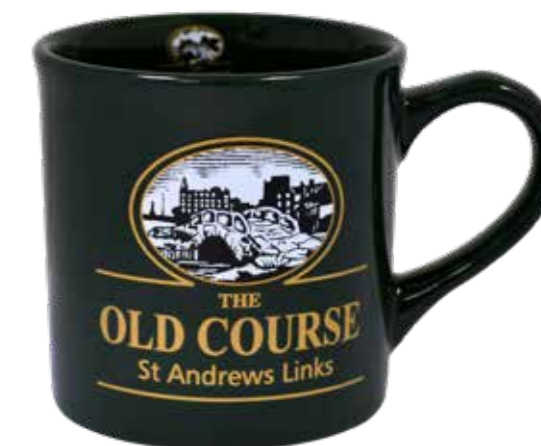

### St Andrews Double Sided Golfers Keyring

#WDGGKEY

- Double sided metal keyring with two Old Course images.
- Ideal for storing keys.
- Dimensions: 7.5cm Height x 3.5cm Width.
- Material: Metal.



Rear View

### St Andrews Faux Leather Fob Keyring

#WDGGFAUXL

- Faux leather key fob with metal keyring.
- The Old Course logo on decal.
- Ideal for storing keys.
- Dimensions: h 8.5cm x w 4cm.
- Materials: Faux Leather, metal & Acrylic.



### St Andrews Old Course Scene Mug

#WDGGMOLD

- The Old Course scene wraparound.
- Material: Bone China.
- Capacity: 295ml (10 fl oz).
- Mug dimensions: 82mm width, 85mm height.
- Not dishwasher safe.



### St Andrews Snow Scene Mug

#WDGGMSNO

- The Old Course snow scene wraparound.
- Material: Bone China.
- Capacity: 295ml (10 fl oz).
- Mug dimensions: 82mm width, 85mm height.
- Not dishwasher safe.



## Golfer's Wash Bag

### GGWSB

- Perfect gift for any golfer.
- Includes:
  - 2 internal mesh pockets,
  - 2 external zip pockets,
  - carry handle.
- 29h x 12w x 16d cm.



## Golfer's Shoe Bag

### GGSB

- Carry your shoes in style.
- Large size comfortably fits shoes & accessories.
- Includes luggage tag.
- 18h x 36w x 19d cm.



\*Shoes not included.

## Hole in One Mug

### GGMUGGM

- Unique mug with archway for desk top putting practice.
- Includes mini golf club and mini golf ball.
- 8oz.



## Potty Putter

### PAPPGT

- Practice your putting while on the job.
- Includes its own putting green, cup with flag, two golf balls, putter and do not disturb door hanger.



## Executive Shoe Shine Kit

### GGSCK

- Neutral & Black Polish, Hard & Soft Brushes, Buffing Cloth.
- Keep shoes looking their best.
- 17h x 12w x 6d cm.



## Golfer's Cufflinks

### GGCUFF

- Classic golfing cufflinks, featuring golf club heads with golf balls.
- Supplied in a silver effect presentation box.



## Perfect Putt

### PARPP

- For the golfing enthusiast.
- Perfect your putting skills.
- Putting sound effect.
- Golf ball not included.
- Requires 2 x AAA batteries.



## Auto Putt Returner

### PAAPB

- Great gadget for improving putting skills.
- Returner shoots back ball when you hit the target.
- Can be used inside or out.
- Ball not included.
- Requires: 2 x C1.5 V batteries.

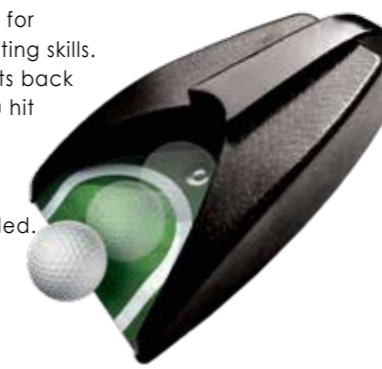

## Golf Ball Globe Game

### GGGLOBE

- Take the Golf Ball Globe challenge.
- Try to put the ball on the tee.
- Ideal executive toy.



## Golf Laser Putter

New 2018

### PALPP Black

- Projects a laser point for aim reference to hole
- Push button ON/OFF switch
- Easily attaches to most putter shafts
- Lightweight
- Requires 2 x LR44 batteries (supplied)
- Actual unit is only 6.5 x 3.2 x 2.5 cm in size and weighs only 21g



## Golf Ball Finder Glasses

### GAVBFC

- Designed to help find lost golf balls.
- Blocks out the majority of unwanted light.
- Handy carrying case.



Without Glasses



With Glasses



Includes Carry Case

## Golf Slippers

### GGGSBL Large 10-12

- Comfortable padded golf slippers with retro tongue and laces.



## Golf Signs

- Size: 31 x 9cm.
- Wooden.

### GGSIGNF 'Born to Golf... Forced to Work'





## Golf Multi Tool

### GGAPK

- Knife with 35mm blade, Pitchfork and ballmarker, Club head brush, Divot repairer, Mini pen & keyring.



## Executive Counter & Multi Tool Set

### GG3IS

- Score counter.
- Combination tool with ballmarker, pitchfork and tee holder.
- Automatic retractable fork.



## 100pc Christmas Tree Tees

### TEXMAS Wooden

- 100 assorted colour wooden tees.



## Caddy Teez

### TEPLCL3

- 3 Novelty golf tees.
- 7.5cm golf tees.



## Strip Teez

### TEPLA6B

- 6 Novelty golf tees.
- 7.6cm golf tees.
- Can also be used as a pitchfork.



## Golf Ball Displays

- All displays can be free standing or mounted on a wall.



## 20 Ball Perspex

### GABCP20

- Display Rack
- 26h x 20.5w x 7d cm



## 49 Ball Wooden

### GABAC49

- Display Rack
- 48h x 46w x 7d cm

## 45 Ball Pyramid

### GABCPT

- Display Rack
- 38h x 39w x 7d cm



## 25 Ball Wooden

### GABAC25

- Display Rack
- 35h x 36w x 7d cm



## Crystal Golf Trophies

Trophies come with a brass plaque suitable for engraving



Acclaim Golfer Trophy  
CR4068B 170mm



Golf Ball Trophy  
CR9035A 180mm  
CR9035C 235mm



Longest Drive Golf Trophy  
CR9256 95mm



Nearest The Pin Golf Trophy  
CR9255 95mm



Challenger Drive Trophy  
CR4036A 110mm  
CR4036B 130mm



Golf Ball Paper Weight  
CR06PW



Golf Ball Tealight Paper Weight  
CRGTH



Golf Ball Trophy  
CR06BT 130mm



Lanark 3D Block Trophy  
CR7214A 90mm  
CR7214B 100mm  
CR7214C 120mm

Ideal for the office. Suitable indoors or out. 5.7 cm diameter. Holds 40mm tea light candles.

## 6pk Sports Golf Balls

### BLSP6

- 6 Assorted golf balls.
- Includes: Football, Pool ball, Tennis ball, Basket ball, American Football & Baseball.



## 6pk Keep Calm Golf Balls

### BLKC6

- 6 assorted golf balls.
- Includes 6 different Keep Calm phrases.



## 6pk Nitro Eclipse Golf Balls

- Titanium polybutadiene core.
- 2 tone colour and semi-transparent.
- Softer feel from Irons.
- Greater distance from drivers.



**BLNIE6MU**  
Multi-coloured

**BLNIE6OY**  
Orange/Yellow

## 12pk Nitro Pulsar MATT Finish

New **2018**

- Flat Matte Finish
- Exceptional distance with a softer feel. The titanium fused hybrid ionomer cover delivers penetrating trajectory with higher lift force.
- Designed to launch high with low spin to create exceptional distance.
- 3 piece tour performance.
- High energy speed core, highly resistant polyobutadiene rubber for exceptional feel.
- HPF metal cover to increase initial ball speed with low spin.
- Titanium fused hybrid ionomer
- 352 large diameter dimples provides a mid-trajectory and stable ball flights
- 90 Compression



**BLNIPM** Multi-coloured  
**BLNIPO** Orange  
**BLNIPL** Lime  
**BLNIPP** Pink

## 6pk Under Par Golf Balls

### BL6PBE

- 3X2 assorted golf balls.



New **2018**

## 6pk Decades Golf Balls

### BL6GE

- 6 Assorted golf balls.
- Includes: 50's, 60's, 70's, 80's, 90's, 00's.



## 2pk Flash Golf Balls

### BLFB2

- Flashes for 5 minutes on contact.
- Ideal for night & twilight golf.
- Includes 2 balls.



The Flash Ball illuminates your shot

## Towel Gift Set

- 2 Fold towel with logo.
- 3 Themed golf balls.
- 5 Themed wooden tees.



**GGNTP**  
Tiger Set

**GGNFNW**  
Blue Football Set

## 6pk Football Golf Balls

- 6 football golf balls.

**BLFBW6**  
Black/White

**BLFNW6**  
Blue/White

**BLFRW6**  
Red/White

**BLFMX6**  
Mixed



## 6pk Camouflage Balls

### BLCAM6

- 6 assorted camouflage golf balls.



## 6pk Atomic Hi-Vis Golf Balls

### BLCR6N

- 2 Yellow 2 orange and 2 neon blue.
- Soft translucent cover creates a soft action.
- Ideal for players with a slower swing speed.
- Accurate touch and alignment for putting.



## 3pk Prank Golfer's Joke Balls

### BLJO3B

- Three different Joke Golf Balls.
- Destroyer: Explodes into a puff of smoke on impact.
- Popper: Turns into streamers when hit.
- Crazy putt: Never goes where you expect.





**BLSPCO15W**  
Control - White

- High control Ball
- Dupont lithium Surlyn cover for maximum cut and abrasion resistance.
- 15 pcs packaging.
- two piece construction.

**BLSPDS15W**  
Distance - White

- High distance Ball
- Dupont lithium Surlyn cover for maximum cut and abrasion resistance.
- 15 pcs packaging.
- two piece construction.

**BLSPFE15W**  
Feel - White

- High feel Ball
- Dupont lithium Surlyn cover for maximum cut and abrasion resistance.
- 15 pcs packaging.
- two piece construction.

**12 pk Spalding Flying Lady Golf Balls**

- Exceptional distance and softer touch.
- Perfect distance at low swing speed.
- Titanium 70 Compression.
- 360 Dimple design.
- Soft cover design.
- Higher tee shots.



**50pk Low Bounce Golf Balls** New 2018

- 50% bounce. For crazy mini golf low bounce.



○ **BLSPFL12W**  
12pk White

● **BLSPFL12P**  
12pk Pink

○ **BLLGB50W**  
White

**Personalised 2 Piece Range / Practice Balls**

- Personalising range balls or range ball stripe.
- Available 1pc or 2pc.
- 85 compression, 330 dimples.
- Timescale 3-4 weeks.



**Striped Range Balls**

- Available 1pc or 2pc.

**Blank 2 Piece Golf Ball**

- Suitable for logo / promotion.

○ **BLRERB2WLO**  
White

● **BLRERB2YLO**  
Yellow

○ **BLRERB2W**  
White

● **BLRERB2Y**  
Yellow

○ **BL2PB**  
White

**RECYCLED LAKE BALLS**

**12pk Colour Box A Grade**



Titleist Lake Balls	<b>LBT2TIM12B</b>
Titleist NXT	<b>LBT2TINXT12</b>
Titleist NXT Tour	<b>LBT2TINXTT12</b>
Nike Lake Balls	<b>LBT2NIM12B</b>
Callaway Lake Balls	<b>LBT2CAM12B</b>

**100pk A/B Grade**



Callaway Hex Chrome	<b>LBACAHC100</b>
Callaway Hex Chrome Plus	<b>LBACAHC100</b>
Callaway HX Black Tour	<b>LBACAHXBT100</b>
Callaway HX Tour	<b>LBACAHT100</b>
Callaway Mix	<b>LBACA100</b>
Nike One	<b>LBANIO100</b>
Nike 20XI	<b>LBANI20XI100</b>
Nike 20XI X	<b>LBANI20XIX100</b>
Nike Mix	<b>LBAN100</b>
Nike RZN Black	<b>LBANIRZNB100</b>
Nike RZN Platinum	<b>LBANIRZNP100</b>
Nike RZN Red	<b>LBANIRZNR100</b>
Nike RZN White	<b>LBANIRZNW100</b>
Srixon Soft Feel	<b>LBASRSF100</b>
Srixon Yellow Mix	<b>LBASRY100</b>
Srixon ZUR	<b>LBASRZUR100</b>
Taylormade Penta	<b>LBATMP100</b>
Taylormade Lethal	<b>LBATML100</b>
Taylormade RBZ Urethane	<b>LBATMRBZU100</b>
Taylormade Tour Preferred	<b>LBATMTP100</b>
Taylormade Tour Preferred X	<b>LBATMTPX100</b>
Titleist Velocity	<b>LBATV100</b>
Titleist Mix	<b>LBAT100</b>
Titleist NXT Tour	<b>LBATNXTT100</b>
Titleist DT solo	<b>LBATDT100</b>
Mixed	<b>LBA100</b>
Orange Mix	<b>LBAOO100</b>
Yellow Mix	<b>LBAOY100</b>

**30pk Titleist NXT A/B Grade**



Titleist NXT	<b>LBA30TINXT</b>
--------------	-------------------

**30 Mixed Lake Balls & 20 Tees**  
**LBA30 White 30pk**

- 30 Value mix grade A & B.
- 20 x 69mm tees & mini pvc golf bag.



**18 Mixed Lake Balls**

**LBA18 White 18pk**

- 18 Value mix A/B grade Lake Balls in PVC draw string bag.



\* Many other grades & balls available - Ask for complete list. Packaging available: Tub, Clamshell, Mesh Bag & Box.

## Wooden Tees

<b>53mm White</b>	<b>69mm White</b>	<b>83mm White</b>
20 TEWO53W	20 TEWO69W	20 TEWO83W
1000 TE1WO53W	40 TEWO4069W 500 TEWO50069W 1000 TE1WO69W	1000 TE1WO83W



<b>53mm Mixed Colour</b>
20 TEWO53
<b>69mm Mixed Colour</b>
20 TEWO69



## 30pk 69mm Tiger Tees

TEWO3069TT Wood



## 50pk 70mm Green Tees

TECS70 Wood

- Made from bio degradable cornstarch.
- 70mm natural colour with markings for tee depth.
- Reusable mesh bag x 50 tees.



## 40pk 69mm Wood Neon Tees

TEW04069PN Pink  
TEW04069MN Mixed



## 2pk Magnetic Tees

TEPCAM2



## 50pk 70mm Patriot Tees

TEW05070IRE Ireland  
TEW05070ENG England



## Big Cup Tees New 2018

TEBC56 Blue 56mm  
TEBC72 Blue 72mm  
TEBC85 Blue 85mm

- 5 pcs pack.
- Large cup allows the ball to be tilted towards the hole as much as 20%.
- Easy ball placement.
- Durable plastic tee with silicone head.



## 100pc Christmas Tree Tees

TEXMAS Wooden

- 100 assorted colour wooden tees.



## Castle Tees

5mm Orange	12mm Red	17mm Blue	25mm Yellow	29mm White	39mm Purple	50mm Orange	50mm Silver
20 TEPCO	20 TEPCR	20 TEPCB	20 TEPCY	20 TEPCW	20 TEPCP	20 TEPCPS	20 TEWOCs
1000TE1PCO	1000 TE1PCR	1000TE1PCB	1000 TE1PCY	1000TE1PCW	1000 TE1PCP	1000 TE1PCPS	*WOOD



## Crown Tees

TEPC6310 63mm 10 Tees



## Mixed Colour Plastic Tees

35mm 20 TEPS 1000 TE1PS  
50mm 20 TEPL 1000 TE1PL



## Extra Long Plastic Tees - 75mm

10pc Extra Long 75mm  
TEPFL White



4 Prong top engineered to reduce friction between ball and tee.

## Driving Range Tee with Friction Hold

- Friction hold: Insert tee & adjust to precise height.

3 Tees S,M & L	TERT
41mm / 100 Bulk	TERTBS
47mm / 100 Bulk	TERTBM
53mm / 100 Bulk	TERTBL
65mm / 100 Bulk	TERTBXL



TERT



TERTBL  
TERTBXL

TERTBM

TERTBS

## Adjustable Slotted Range Tee

TERTD 2pc Blister  
TERTDL 100pc Bulk

- 60mm Yellow rubber tee.
- Insert tee and adjust to your desired height.
- Designed with a slit to let tee fall forward and not break.



## Jumbo Rubber Winter Tees

TERWJ4

- 4pk includes: 38mm, 22mm, 18mm, 13mm



## CHAMP ZARMA FLYTEE

### White Zarma FlyTee™

- 20 Pcs 44mm/1-3/4" **TECHFT4420WH**
- 30 Pcs 69mm/2-3/4" **TECHFT7040WH**
- 25 Pcs 83mm/3-1/4" **TECHFT8330WH**

- Increase accuracy.
- Gain greater distance from driver.
- 6 Prong head makes it easier to place the ball on the tee and keeps the ball stable.
- Reinforced shank for durability.
- Environmentally friendly.



### 30pk Champ Zarma FlyTee™

CHAMP Multi FLYtees 30 x 2 3/4" (69mm) Tees.

- |        |             |                     |
|--------|-------------|---------------------|
| Mix    | 69mm/2-3/4" | <b>TECHFT40MIX</b>  |
| Orange | 69mm/2-3/4" | <b>TECHFT7040OR</b> |
| Yellow | 69mm/2-3/4" | <b>TECHFT7040YW</b> |
| Red    | 69mm/2-3/4" | <b>TECHFT7040RD</b> |
| Pink   | 69mm/2-3/4" | <b>TECHFT7040PK</b> |
| Black  | 69mm/2-3/4" | <b>TECHFT7040BK</b> |
| Blue   | 69mm/2-3/4" | <b>TECHFT7040BL</b> |
| Green  | 69mm/2-3/4" | <b>TECHFT7040GR</b> |
| Neon   | 69mm/2-3/4" | <b>TECHFTN40MIX</b> |



### My Hite FlyTee™

CHAMP My Hite FLYtees feature dark coloured lines on the shaft of the tee so that you never have to struggle at locating the correct height for your driver.



- 25 Pcs Blue 83mm/3-1/4" **TECHFTMH8330**
- 30 Pcs Red 69mm/2-3/4" **TECHFTMH7040**

### Champ Display Stand

**SACHT12**

Free with 24 pack order  
Tees not included



Champ Zarma Flytee Feature

### Lignum Tee #1 Tee in Europe

**RINGSYSTEM THE POWER OF HEIGHT CONSISTENCY.**

Lignum are the first Tee with integrated height control - the innovative mechanism allows players to quickly and easily set up the same height over and over again.



**LIGNUMTEE**  
FOR A BETTER GAME

**MICROWOOD.**  
Lignum Tees use specially developed environmental material for perfect stability.

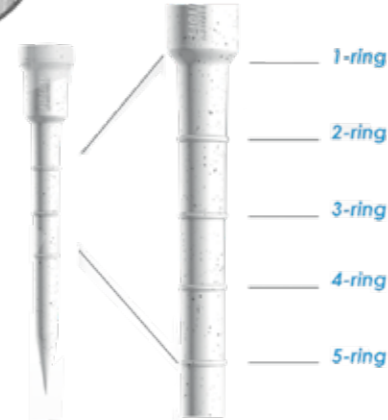

**MIXED 4**  
(Blue/Red/  
Yellow/White)

### EASY EXIT SMART BAG.

The easy exit system allows for simple and fast removal of single tees, with no package tear down. The Smart Bag is easy to store on the course and preserves tee size order.

53mm White	62mm White	53mm Mixed	62mm Mixed
16 Pack <b>TELT5316W</b>	16 Pack <b>TELT6216W</b>	16 Pack <b>TELT5316</b>	16 Pack <b>TELT6216</b>
72mm White	82mm White	72mm Mixed	82mm Mixed
12 Pack <b>TELT7212W</b>	12 Pack <b>TELT8212W</b>	12 Pack <b>TELT7212</b>	12 Pack <b>TELT8212</b>

### Pride PTS Tees

**CHOOSE YOUR COLOUR, CHOOSE YOUR SIZE.**

Choose the tee length that is appropriate for your driver or club. Longer tees are recommended for drivers with larger club heads.

**Pride Professional Tee System™**

54mm Red	69mm Yellow	83mm Blue	102mm Green
120 Pack <b>TEPSPTS54120</b>	100 Pack <b>TEPSPTS70100</b>	75 Pack <b>TEPSPTS8375</b>	50 Pack <b>TEPSPTS10250</b>



- 54mm : for Clubs/Low Profile Woods
- 69mm : For Drivers under 360cc
- 83mm : For Drivers over 360cc
- 102mm : For Drivers over 360cc



BALLS. TEES & SPIKES

## Champ Stinger™ Spikes

Scorpion STINGER spikes are non-clogging and made with a soft durometer TPU for superior comfort and durability. Wrench holes formed in the rigid material hug a "C" visible wear indicator which turns solid when spikes need to be replaced.



18 Q-Lok Disk Packed	<b>SACHST22Q</b>
18 Fast-Twist 3.0 Disk Packed	<b>SACHST22T</b>
22 Standard Disk Packed	<b>SACHST22S</b>
400 Q-Lok in Bowl	<b>SACHST400Q</b>
400 Fast-Twist 3.0 In Bowl	<b>SACHST400T</b>
400 Standard In Bowl	<b>SACHST400S</b>

## Champ Pro Stinger™ Spikes

With PRO STINGER spikes you can play in any weather. The soft durometer TPU providing superior comfort and durability. The metal tip provides unsurpassed traction with non clogging support pods.



18 Fast-Twist 3.0 Disk Packed	<b>SACHPS22T</b>
-------------------------------	------------------

## Champ Zarma® Spikes

Zarma spikes are built with a three material design that has an innovative soft cushion layer sandwiched between a durable traction layer and a rigid attachment layer. All three layers are held together using advanced polymer moulding techniques. Lotus Technology uses compression to soften the impact of walking, this reduces spike pressure and creates a more comfortable experience for the golfer.

3 Material Design  
Durable Construction



18 Fast-Twist 3.0 Disk Packed	<b>SACHZA16T</b>
-------------------------------	------------------

## Champ Zarma® Spikes Pins System

20 Zarma PINS System	<b>SACHZAAD20</b>
----------------------	-------------------

\*This product is compatible with the PINS system on Adidas shoes\*

Please note rolling change from slim look to FTS 3.0 on all model from mid 2018

## Champ Zarma® RST/Under Armour Spikes New 2018

Zarma spikes are built with a three material design that has an innovative soft cushion layer sandwiched between a durable traction layer and a rigid attachment layer. All three layers are held together using advanced polymer moulding techniques. Lotus Technology uses compression to soften the impact of walking, this reduces spike pressure and creates a more comfortable experience for the golfer.

Suitable for shoes released by Under Armour in 2016-2018. Uses the Fast-Twist 3.0 insert system.

Pack includes:  
2-Prong insertion wrench,  
Zarma Tour cleat disk,  
Rotational resistance spikes.



20 Fast-Twist 3.0 Disk Packed	<b>SACHZAU20</b>
-------------------------------	------------------

## Champ Footjoy Stinger™ Spikes

Footjoy STINGER spikes provides superior traction in any weather while maintaining maximum comfort. The spikes are specifically designed for Footjoy golf shoes, and feature durable wrench holes, wear indicators, and a non-clogging and green friendly design that minimises damage marks on the green.



18 Footjoy Tri-Lok Disk Packet	<b>SACHSTFJ18</b>
--------------------------------	-------------------

## Champ Helix™ Spikes Pins System New 2018

The HELIX spike is designed with superior rotational traction to help give the best stability and keep you grounded throughout the swing. The six firm legs provide the top level of traction in the CHAMP range and the "C" visible wear indicator turns solid when spikes need to be replaced. The HELIX also uses a green friendly design which minimises marks on the green allowing for a comfortable playing experience.



20 Pins System Disk Packed	<b>SACHHP</b>
----------------------------	---------------



Wear Indicator  
"C" Visible Wear Indicator turns solid when worn

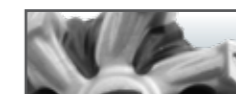

Environmental  
Green friendly design



Traction Element  
Strong abrasion resistant urethane



Reinforced Wrench Holes  
Rigid base with durable holes

## Champ S6 Display

**SACHS6**  
• 13" W x 9" d x 14.25" H.



### Fast twist 3.0®

### THIS INNOVATIVE NEW INSERT SYSTEM Replaces All of These Previous Insert Systems

- Thread enhancements for better cleat retention.
- Fast Twist 3.0 cleats are backward compatible and will work in certain older receptacles.
- Unique design ensures that only Fast Twist 3.0 cleats will fit in Fast Twist 3.0 receptacles.



The New Fast Twist 3.0® receptable

### BACKWARD COMPATIBLE



Fast Twist 3.0® Pulsar Cleat

Fast Twist 3.0 cleats will fit in all Tour Lock, Fast Twist, Slim-LOK, & Tri-LOK receptacles found in select golf shoes from the following brands:



### Golfer's Wash Bag

#### GGWSB

- Perfect gift for any golfer.
- Includes: 2 internal mesh pockets, 2 external zip pockets, carry handle.
- 29h x 12w x 16d cm.



### Golfer's Shoe Bag

#### GGSB

- Carry your shoes in style.
- Large size comfortably fits shoes & accessories.
- Includes luggage tag.
- 18h x 36w x 19d cm.



\*Shoes not included.

### Champ MaxPro™

#### SACHAMP



### Longridge Golf Wrench

#### SASW Spike Wrench



### Dasco Shoe Laces

- 75cm length.
- Sold as a 6 pack.



● SALA75BLK Black

● SALA75BRN Brown

### Executive Golf Bag & Accessories

#### GGSBCC

- Includes: Cleaning brush with shoe spike shoe spike removal tool, cleaning cloth, shoe polish and dual club brush.
- Premium quality shoe bag with air vents, side pockets and carry handle.



### Tour Golf Shoe Bag

#### SASBD

- Great for storing wet and muddy shoes.
- Luxury fleece lining & divider protects shoes.
- Valuables zipped pouch.
- Breathable mesh panel.
- Carry handle.



### Dasco Deluxe Shoe Care Set

#### CAKISK

- 1 Black shoe wax polish.
- 1 Neutral shoe wax polish.
- 1 Shoe horn.
- 2 Shoe brushes.



### Executive Shoe Shine Kit

#### GGSCK

- Keep shoes looking their best.
- Neutral & Black Polish.
- Hard & Soft Brushes.
- Buffing Cloth.



### Mesh Golf Shoe Bag

#### SASBMB

- Great for storing wet and muddy shoes.
- Protects shoes.
- Valuables zipped pouch.
- Breathable mesh panel.
- Carry handle.



### Executive Mesh Shoe Bag

#### SASBE

- Breathable mesh panel.
- Large zipped compartment.
- Top easy carry handle.
- Protects shoes.



### Cherry Blossom Shoe Care

Cherry Blossom: are a comprehensive range of shoe care products and accessories especially designed to shine, protect, nourish, revive and restore footwear made from a range of different materials.



CACBUP Universal Protector

CACBUC Universal Cleaner Foam Spray

CACBSD Shoe Deodorant



CACBDU Neutral Dubbin



SACBISGL Premium Gel Insole (Size 4-8)



CACBWH Sport Whitener



SACBISGM Premium Gel Insole (Size 8-11)



SACBSHS 15cm Shoe Horn



**ENERTOR™**

POWERED BY D3O

# STAY IN THE GAME

## PROVEN INJURY REDUCTION INSOLES

- Patented D3O® technology for ultimate shock absorption
- Trusted by pros, the British Army, US Military and Usain Bolt

**FOOT PAIN | ANKLE PAIN | LEG PAIN | KNEE PAIN | BACK PAIN**

ADVANCED SHOCK ABSORBING INSOLES for longer lasting PAIN RELIEF and INJURY PREVENTION

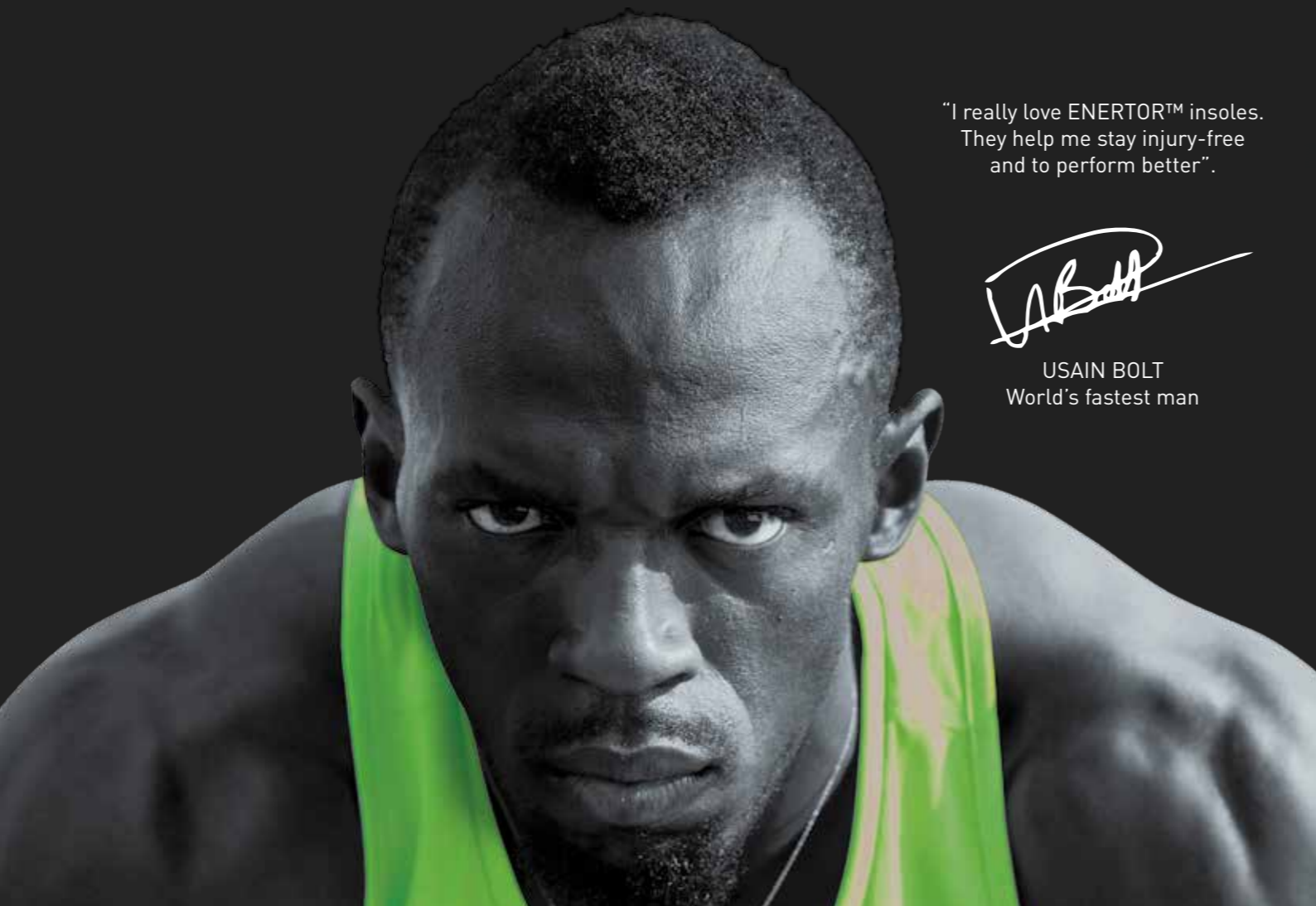

"I really love ENERTOR™ insoles. They help me stay injury-free and to perform better".

USAIN BOLT  
World's fastest man

### HOW D3O® WORKS

FREE FLOWING MOLECULES

SOFT & FLEXIBLE MATERIAL

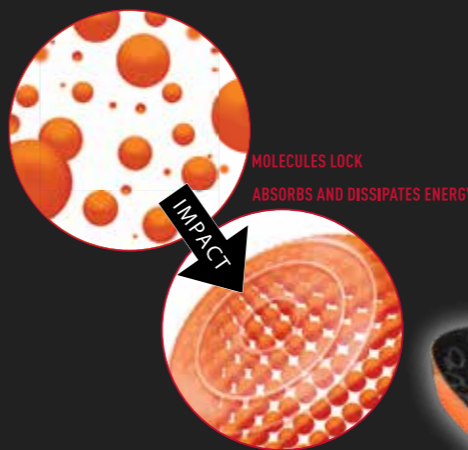

### Performance - Full Length

- Ideal for sports and hiking,
- Long lasting insoles to improve performance and reduce injury.
- The insole will reduce the amount of pronation (foot going inwards) and gives maximum control and stabilisation of the foot.

SAENPE# Available in UK Sizes: 3 - 14



### Comfort - Full Length

- Perfect for everyday use.
- Protects heel and mid foot on impact. Walk on air, or stand all day in comfort.
- Will feel like having a new pair of your most comfortable shoes on.
- As used by the British Forces.

SAENCFL# Available in UK Sizes: 3-4, 5-6, 7-8, 9-10, 11-12, 13-14

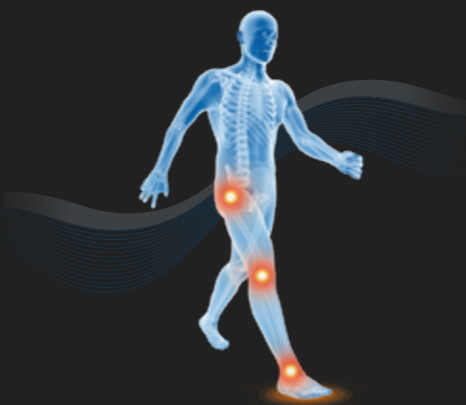

### Comfort - 3/4 Length

- Perfect for everyday use and in tight-fitted shoes, where additional material in the toe box becomes too tight.
- 3/4 length doesn't slide around under the foot, it sticks to your shoes.
- Protects heel and mid foot on impact. Walk on air, or stand all day in comfort.
- Some golfers and skiers will prefer to feel their toes.

SAENC34L# Available in UK Sizes: S (1-5), M (6-9), L (10-14)



### Comfort - Heel Cups

- Perfect for any shoes and high heels.
- Sticks to the shoes to ensure they sit correctly under the heel.
- Protects your heels every time you hit the ground.
- Having a pair of discreet Heel Cups is a good start to improve your well being and to avoid heel pain.

SAENCHC# Available in UK Sizes: S (1-5), M (6-9), L (10-14)



### Enertor Floor Standing FSDU

SAEN64FSDU  
64pk FSDU

- Holds a maximum of 64 packs of various sizes.



\*69% of sufferers reported the Enertor insoles helped to heal Plantar Fasciitis, 120 person study, UK Jan 2017. † As validated by leading independent test house.



Designed in the UK

Tested and endorsed by  
**ROYAL AIR FORCE**





CONSISTENT  
HAND PLACEMENT.

CONSISTENT  
RESULTS.



MCC™ ALIGN  
FRONT & BACK VIEW



MCC PLUS 4™ ALIGN  
FRONT & BACK VIEW

Golf Pride®  
GRIPS



**RAISED RIDGE**

When installed on shaft, the red ridge rises, allowing for consistent hand placement and heightened club face awareness.

**FIRMER MATERIAL ON RIDGE**

50% firmer ridge material amplifies pronounced feel.

**MICRO-DIAMOND TEXTURE**

Distinctive ridge texture for consistent hand placement.

**CARVED CHANNELS**

Flex channel increases ridge lift and helps lock in hands.

**ALIGN**  
TECHNOLOGY

**MMC Plus 4 Cord Align®**



Standard: GRMEMCCP4AGY  
Midsize: GRMEMCCP4MAGY

**MMC Cord Align®**



Standard: GRMEMCHAWH  
Midsize: GRMEMCHAMWH

NEW DECADE® MULTICOMPOUND  
**MCC PLUS 4**

THE #1 HYBRID GRIP  
ON TOUR ADDS A  
**NEW**  
PERFORMANCE OPTION

**UPPER HAND TECHNOLOGY**

Soft Rubber Compound combined with Moisture Wicking Brushed Cotton Cord for maximum performance with control. New Micro-Texture engineered for softer feel and Strategically-placed for high traction.

**LOWER HAND TECHNOLOGY**

4.6% Larger Outside Diameter for lighter grip pressure and increased swing speed. 20% Softer Rubber in lower half for Optimum Feel in Non-Glove Hand\* \*20% Softer compared to Upper Hand. Tour-Inspired design to Match the Feel of Building Up Your Grip with 4 Extra Layers of Tape.



Standard:	GRMEMCCP4	GY	BL	RD	OR	GR
Midsize:	GRMEMCCP4M	GY	BL			
Undersize:	GRMEMCCP4U	GY				
Jumbo:	GRMEMCCP4J	GY				

**New Decade® Multi Compound**

This innovative hybrid grip fuses the positive performance of rubber and cord for an exciting new look and feel. The Multi-Compound boasts Golf Pride's exclusive black Velvet Cord in the upper hand area for firm all-weather control, and a hi-performance rubber material in the lower hand for ultimate control and responsiveness.



Standard:	GRMEMCH	W	BK	B	Y
Midsize:	GRMEMCHM	W	BK	B	Y



GRIPS & WORKSHOP

## Tour Wrap® 2G®

With a modernised look and fresh colours, the Tour Wrap® 2G® features enhanced tackiness and an even softer material for a great feel. This one-piece, simulated wrap grip combines the look and feel of luxury leather with the durability and performance of high-tack rubber.



Standard: GRMETW2G **B** **BL** **W** **R**  
 Midsize: GRMETW2G **BM** **WM**

## Tour Velvet Align® **New 2018**

Tour Velvet Align features an advanced Non-slip material that delivers maximum playability and confidence in all-weather conditions. The new ALIGN Technology improves clubface awareness and brings more consistency to your game.



Standard: GRMETVA **BK**  
 Midsize: GRMETVAM **BK**

## Tour Velvet Super Tack™

Tour Velvet Super Tack features an advanced new material formulation that delivers significant tack. The enhanced texture increases surface coverage by +33% for added traction while the distinct diamond pattern in the top section of the grip allows for added stability.



Standard: GRMETVSTBK      Midsize: GRMETVSTMBK

## Tour Velvet Cord® BCT® Gold

The most widely used cord grip on Tour, the Tour Velvet® BCT® Cord comes standard with Brushed Cotton Technology (BCT), a tighter-weave cotton twill fibre that delivers a comfortable cord grip.



Standard: GRMETVB **BK**

## Tour Velvet® 360™

Tour Velvet® 360 is designed for adjustable drivers, fairway woods, and hybrid clubs. It features the popular look and feel of the Tour Velvet® non-slip surface pattern in a 360° design.



Standard: GRMETV360



Standard: GRMETV360W  
 Midsize: GRMETV360WM **New 2018**

## Tour Velvet®

The most popular grip in golf today combines an exclusive, state-of-the-art rubber-blend compound with a computer-designed, non-slip surface pattern for maximum playability, comfort & confidence.



Standard (Ribbed): GRMETV      Midsize: GRMETVM  
 Standard (Round): GRMETVRO      Jumbo: GRMETVO  
 Standard (Round)0.6: GRMETVRO60      Undersize: GRLETV

## Z-Grip® Cord: The Fastest Growing Full Cord Grip On Tour

The Z-Grip Cord is Golf Pride's firmest cord grip, combining two layers of texturing for feedback and control. A deep "Z" shaped texture pattern winds vertically around the grip for enhanced traction, while a heavy cord texture throughout provides moisture management and responsiveness.



Standard: GRMEZ      Midsize: GRMEMZ

## VDR®

Featuring three depths of surface grip texture, the VDR® is specifically designed for heightened traction and excellent all-weather performance. The precision-cut, variable depth texture, combined with a shock-reducing rubber compound provides wrist protection from off-centre strikes.



Standard: GRMEVDR **BK**

## Tour SNSR Putter Series®

NEVER LOSE YOUR FEEL. Golf Pride's new oversized putter series called TOUR SNSR™ features larger Tour-proven shapes that are engineered with innovative SNSR material that delivers unsurpassed Tour-level feel and feedback. The new grips are made of a soft-tuned rubber formulation that gives these grips an extraordinary feel, and encourages a lighter grip pressure that golfers seek in creating a smooth stroke. The new SNSR compound also enhances Tour-level feedback into the hands to improve player distance control. Players can dial in the feel that fits them best with two Tour proven shapes, the TOUR SNSR CONTOUR and the TOUR SNSR STRAIGHT. All four TOUR SNSR models feature a wide paddle front, sculpted to promote lighter grip pressure and consistent hand placement. Additionally, they are each finished with a traction-textured design that provides heightened feel and moisture control. Each shape is available in two oversize options, 104cc and 140cc.

## TOUR SNSR PISTOL CONTOUR®

An evolution of the classic tapered pistol profile that is the shape preference of over 75% of Tour players. The pistol allows golfers to "lock in" their upper hand for consistent hand placement that translates to more confidence in every stroke.



104CC: GRPETSP104



140CC: GRPETSP140

## TOUR SNSR STRAIGHT®

A contemporary, non-taper shape promoting a consistent hand pressure and feel. The straight taper design features soft, rounded edges that are strategically bevelled for palm and finger pad comfort.



104CC: GRPETSS104



140CC: GRPETSS140

TOUR SNSR CONTOUR  
 Never loose your feel with Golf Pride's new oversized putter series TOUR SNSR™

CP2 WRAP™  
 Engineered rubber compound for comfort and performance.

Core Size: 60 Round  
 Weight: 51.5g Std,  
 64g Mid, 81g Jumbo

## CP2 Wrap™ & CP2 Pro™ Grips: Golf Pride's Softest Performance Grip

The CP2™ grip by Golf Pride is the softest performance comfort grip. The exclusive Control Core™ technology reduces torque by 41% compared to a grip without the core. Soft rubber with a detailed texture provides both comfort and traction. A reduced taper in the lower hand encourages light grip pressure. Available in CP2 Pro™ and CP2 Wrap™ options. Sizes include standard, midsize, and jumbo.

		
<b>CP2 WRAP</b>		<b>CP2 PRO</b>
Undersize: GRMEUCP2WBK		Undersize: GRMEUCP2PBK
Standard: GRMECP2WBK		Standard: GRMECP2PBK
Midsize: GRMEMCP2WBK		Midsize: GRMEMCP2PBK
Jumbo: GRMEJCP2WBK		Jumbo: GRMEJCP2PBK

## Tour Tradition® Putter Grip

The Tour Tradition® features a smaller, paddle front design preferred by Tour professionals. Its standard size and all-rubber construction provides increased feel and responsiveness for truer putts.



Standard: GRPETT BK

## Tour Classic® Putter Grip

The Tour Classic® midsize design features a large diameter, filling the hands comfortably while the flat paddle front promotes a controlled, confident stroke.



Standard: GRPETC BL

## B-140® Belly Putter

A 21" flat paddle construction allows players to utilise several gripping styles to produce a consistent roll. This unique design structure is optimised for easy installation.



Standard: GRPEBPB

## David Leadbetter™ Training Grip

Designed to be an excellent practice tool for learning and reinforcing the mechanics and feel of proper hand placement on the club. This grip will help beginners as well as advanced players.



Standard RH: GRMETL

**TOUR CLASSIC®**  
Flat paddle front promotes a controlled, confident stroke.  
Core Size: 58 Round  
Weight: 84g Mid

## Winn Tour Pistol Putter Grip

The Tour Pistol is designed for players who prefer a traditional size & shape putter grip. Well-defined edges offer accurate alignment & consistency. All models come in a unique tone-on-tone color look with an enhanced hexagon pattern, which provides great feel and slip-resistance, promoting light grip pressure. Excel polymer provides a comfortable tacky feel.



Standard: GRPWTP BK BL LV RD

## Winn Pro X 1.18" Midsize Putter Grip

Slightly larger than a Winn Midsize putter grip, the black & red 1.18" model uses a comfortable, tacky Excel polymer for ultimate feel. The paddle-style profile eliminates wrist movement during the stroke.



Midsize: GRPWPXS BR

## Winn Pro X 1.32" Midsize Putter Grip

This 1.32" diameter grip feels slightly smaller than the Winn Jumbo putter grip. Its minimally tapered profile reduces wrist movement during the stroke for more consistency on the greens. The tacky Excel polymer provides comfort and confidence.

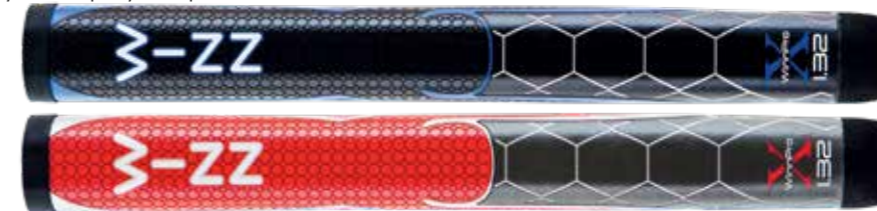

Standard: GRPWPXR BB RG

## Winn Pro X 1.60" Jumbo Putter Grip

The extreme oversized 1.60" diameter of this grip helps eliminate wrist movement while putting, aided by the minimally tapered profile.



Jumbo: GRPWPXF BS

## Winn 21" Pistol Belly Excel Putter

For long putters, this 21-inch one piece grip offers the shape of a pistol with the length of a 2-piece. Our original Excel polymer provides a soft, tacky feel.



Long: GRPWPBRB

## Winn Pistol Putters

Winn's Pistol Putters are popular because of their stabilizing effects on wrist movement. The soft, tacky Excel polymer provides ultimate comfort in your hands.



Midsize: GRPWMEPBO



Jumbo: GRPWJEPBK

**winn**  
Grips



**TOUR PISTOL:**  
0.59" DIAMETER  
For players who prefer a traditional size & shape putter grip.  
Core Size: 59 Round  
Weight: 62g Std

## PISTOL GT



The new Pistol GT with CounterCore Technology is a mid-sized, classic pistol shape that golfers love. CounterCore Technology lets golfers fine tune the feel and stability of the putter by adjusting the weight of the grip. Every new CounterCore putter grip comes with a 50g back-weight that engages larger muscles in the arms, shoulders and back, which results in more of a pendulum motion. Our patented NO TAPER design promotes even grip pressure, which leads to better putting. It can also be played without the weight if you prefer.

<b>1.0</b>	Diameter: 1.10" Length: 10.50" Weight: 52g Core: 0.58	<b>1.0:</b>	<b>GRPSSCPG1</b>	<b>BK</b> <b>BL</b>
		<b>1.0 Midnight:</b>	<b>GRPSSCPG1</b>	<b>BM</b>
<b>2.0</b>	Diameter: 1.20" Length: 10.50" Weight: 70g Core: 0.58	<b>2.0:</b>	<b>GRPSSCPG2</b>	<b>BK</b>
		<b>2.0 Midnight:</b>	<b>GRPSSCPG2</b>	<b>BM</b>
<b>TOUR</b>	Diameter: 1.00" Length: 10.50" Weight: 50g Core: 0.58	<b>Tour:</b>	<b>GRPSSCPGT</b>	<b>BK</b> <b>BL</b>
		<b>Tour Midnight:</b>	<b>GRPSSCPGT</b>	<b>BM</b>

## LEGACY



### MID SLIM 2.0

The **MIDSLIM 2.0** is slightly smaller than the SLIM 3.0 but still features SuperStroke's patented parallel technology. This size-to-weight combination has quickly become a favourite across all professional golf tours.

### SLIM 3.0

The **SLIM 3.0** is one of the hottest grips on tour. Used in 3 Major Championship wins, the Slim 3.0 promotes stability throughout the entire putting stroke while providing great feel and feedback.

### FATSO 5.0

The **FATSO 5.0** is a time-tested performer and the shape that started it all. The FATSO not only continues to win but has prompted the development of new sizes and profiles.

<b>2.0</b>	Diameter: 1.20" Length: 10.50" Weight: 50g Core: 0.58	<b>2.0:</b>	<b>GRPSSCL2</b>	<b>BK</b> <b>RD</b> <b>BL</b> <b>LI</b>
<b>MID SLIM</b>		<b>2.0 Midnight:</b>	<b>GRPSSCL2</b>	<b>BM</b> <b>YM</b>
<b>3.0</b>	Diameter: 1.30" Length: 10.50" Weight: 60g Core: 0.58	<b>3.0:</b>	<b>GRPSSCL3</b>	<b>BK</b> <b>RD</b> <b>BL</b> <b>LI</b>
<b>SLIM</b>		<b>3.0 Midnight:</b>	<b>GRPSSCL3</b>	<b>BM</b> <b>YM</b>
<b>5.0</b>	Diameter: 1.67" Length: 10.50" Weight: 90g Core: 0.58	<b>5.0:</b>	<b>GRPSSCL5</b>	<b>BK</b>
<b>FATSO</b>		<b>5.0 Midnight:</b>	<b>GRPSSCL5</b>	<b>BM</b>

## FLATSO



The **FLATSO Series** features a revolutionary pentagonal profile, providing players a different feel than the Legacy Series. This patented shape allows for increased repeatability and consistency due to its wider flat front and multiple edges.

<b>1.0</b>	Diameter: 1.10" Length: 10.52" Weight: 85g Core: 0.58	<b>1.0:</b>	<b>GRPSSCXFL1</b>	<b>BK</b> <b>RD</b> <b>BL</b>
		<b>1.0 Midnight:</b>	<b>GRPSSCXFL1</b>	<b>BM</b>
<b>2.0</b>	Diameter: 1.25" Length: 10.50" Weight: 52g Core: 0.58	<b>2.0:</b>	<b>GRPSSCXFL2</b>	<b>BK</b> <b>RD</b>
		<b>2.0 Midnight:</b>	<b>GRPSSCXFL2</b>	<b>BM</b>
<b>3.0</b>	Diameter: 1.40" Length: 10.50" Weight: 60g Core: 0.58	<b>3.0:</b>	<b>GRPSSCXFL3</b>	<b>BK</b>
		<b>3.0 Midnight:</b>	<b>GRPSSCXFL3</b>	<b>BM</b>



**ODYSSEY** SuperStroke has partnered with Odyssey Golf to add our patented parallel technology to their line of putters. These grips are identical to the grips installed by Odyssey.

**2.0**

Diameter: 1.20"  
Length: 10.50"  
Weight: 50g  
Core: 0.58



**2.0: GRPSSOD2**



**SS2R**  
SQUARE PROFILE

Diameter: 1.00"  
Length: 10.50"  
Weight: 100g  
Core: 0.580

Red: **GRPSSYSSQRD**



The **SS2R** Square Profile grip is a truly revolutionary design. Its solid rubber underlisting provides good back-weighting and excellent feedback. The proprietary PU outer skin and Cross-Traction pattern are the same as found on all SuperStroke models.



**PLUS EXTRA**  
SERIES LONG

**2.0 XL**

Diameter: 1.20"  
Length: 13.75"  
Weight: 68g  
Core: 0.58

**2.0XL: GRPSSZCL2XL**  
**BK** **YW**

**3.0 XL**

Diameter: 1.30"  
Length: 13.75"  
Weight: 80g  
Core: 0.58

**3.0XL: GRPSSZCL3XL**  
**YW**

**2.0 XL**  
**FLATSO**

Diameter: 1.30"  
Length: 13.75"  
Weight: 80g  
Core: 0.58

**2.0XL: GRPSSZCFXL**  
**BK** **YW**



**PLUS SERIES** Grips provide the ability to add back-weighting to any putter to achieve optimum balance. With new proprietary threaded cap design, players can quickly and easily install a 50g weight to instantly change the feel and balance.

CounterCore Technology  
50g CounterCore weight is sold separately

One size fits all:  
**GASS50CW2XL**



**PREMIUM CLUB GRIPS** Hard-cord design Cord upper half. Soft, tacky cord for increased club control.

**Signature cross-traction contact pattern** Improves grip over entire surface.

**Rubber lower half** Soft, non-cord rubber for enhanced feel and feedback. Soft, tacky cord for increased club control.

Length: 10.75"  
Standard: 52g  
Midsize: 62g  
Core: 0.6

Standard: **BK** **BL** **GY**  
**GRMSSTX** **RD** **LM**  
Midsize: **GRMSSTXXM** **BK**



## S-TECH

The new S-Tech club grip has a soft, tacky feel from premium rubber compound that deliver excellent feedback and control. The Cross-Traction surface texture provides an incredible non-slip surface in all weather conditions, which enhances control and performance.

Length: 10.75"  
Standard: 52g  
Midsize: 52g  
Core: 0.6

Standard: **BK** **BL** **GY**  
**GRMSST**  
Midsize: **GRMSSTM** **BK**



## MIDNIGHT SERIES

Black/White  
2.0 Putter Grip: **GRPSSM2BKW**  
3.0 Putter Grip: **GRPSSM3BKW**



# LEGACY

## ULTRA SLIM 1.0

The **ULTRASLIM 1.0** features the smallest profile within the Legacy series. It is preferred by golfers that don't require as much wrist stabilization or those with smaller hands.

## MID SLIM 2.0

The **MIDSLIM 2.0** is slightly smaller than the SLIM 3.0 but still features SuperStroke's patented parallel technology. This size-to-weight combination has quickly become a favourite across all professional golf tours.

## SLIM 3.0

The **SLIM 3.0** is one of the hottest grips on tour. Used in 3 Major Championship wins, the Slim 3.0 promotes stability throughout the entire putting stroke while providing great feel and feedback.

## FATSO 5.0

The **FATSO 5.0** is a time-tested performer and the shape that started it all. The FATSO not only continues to win but has prompted the development of new sizes and profiles.

**1.0** ULTRA SLIM  
**Diameter:** 1.00" **1.0: GRPSSL1** **BK**  
**Length:** 10.50"  
**Weight:** 65g  
**Core:** 0.58

**2.0** MID SLIM  
**Diameter:** 1.20" **2.0: GRPSSL2** **BK RD BL**  
**Length:** 10.50"  
**Weight:** 50g  
**Core:** 0.58

**3.0** SLIM  
**Diameter:** 1.30" **3.0: GRPSSL3** **BK RD BL**  
**Length:** 10.50"  
**Weight:** 60g  
**Core:** 0.58

**5.0** FATSO  
**Diameter:** 1.67" **5.0: GRPSSL5** **BK RD**  
**Length:** 10.50"  
**Weight:** 90g  
**Core:** 0.58



**TAPELESS INSTALLATION**



**FAST, CLEAN & EASY**



**THERE'S NOTHING LIKE HITTING A PERFECT SHOT**

# FLATSO

The **FLATSO Series** features a revolutionary pentagonal profile, providing players a different feel than the Legacy Series. This patented shape allows for increased repeatability and consistency due to its wider flat front and multiple edges.

**1.0**  
**Diameter:** 1.10" **1.0: GRPSSXFL1** **BK**  
**Length:** 10.52"  
**Weight:** 85g  
**Core:** 0.58

**2.0**  
**Diameter:** 1.25" **2.0: GRPSSXFL2** **BK**  
**Length:** 10.50"  
**Weight:** 52g  
**Core:** 0.58

**3.0**  
**Diameter:** 1.40" **3.0: GRPSSXFL3** **BK**  
**Length:** 10.50"  
**Weight:** 60g  
**Core:** 0.58

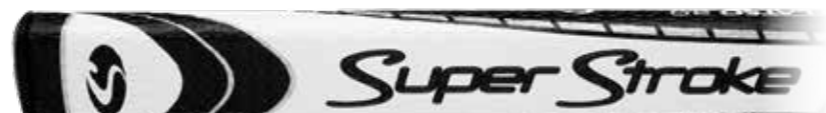

**EXCEPTIONAL QUALITY GRIPS**  
**100% PURE RUBBER**





**EXCEPTIONAL QUALITY | TAPELESS INSTALLATION  
UNIQUE PURE RUBBER COMPOUND**

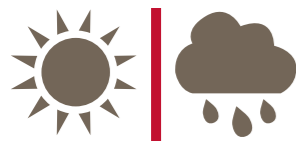

**Feel & Durability**

Exceptional durability.  
Best feel on the market.  
Best in all weather conditions.  
High Level of moisture & heat resistance.



**Tapeless Installation**

No adhesive tapes or solvents.  
Grips as securely as adhesive tape.  
Install on steel or graphite shafts.  
Grip will not loosen or slip.

- LASTS TWICE AS LONG.....** 100% pure rubber makes it exceedingly durable.
- SUPER "TACKY" .....** Guaranteed to remain tacky and supple for 12 months.
- BETTER IN RAIN .....** Due to the material, moisture doesn't attach to the grip as easy and makes it easier to wipe off.
- MADE IN USA .....** Injection mold ensure grips are consistent thickness.
- CUSTOM LOGO .....** Minimum quantity of 13, with 3 weeks lead time.
- USE ON PREMIUM BRANDS..** Miura, Bettinardi, PXG etc.



**Benefits**

No adhesive tapes or solvents yet grips as securely as adhesive tape.  
Installs on steel or graphite shafts 75% quicker than traditional methods.  
Will not slip or turn once in place a clubs can be used immediately.  
Easier to learn than traditional grip application.

**Air Compressor New 2018**

Lightweight and portable for great manoeuvrability.  
Suitable for inflating, short spraying and blowing.  
Supplied with 4 x rubber feet.  
This compressor has been selected because of its silent operation.  
In a shop environment its important to keep the noise down.



**Custom Installer**

PURE Custom Installation  
Attachment is threaded to fit standard air compressor parts.

**Corporate & Personal Grip Customisation**

**GIVE CUSTOMERS SOMETHING UNIQUE.  
THE HIGHEST QUALITY GOLF GRIP WITH THEIR OWN LOGO.**



**IN JUST SECONDS A GRIP CAN BE INSTALLED ON A CLUB FOR EVERY PLAYER AT THEIR EVENT OR TOURNAMENT.**

MIN ORDER 13 GRIPS, 4 WEEK LEAD TIME.  
\*NOTE, ONLY 1 CHOSEN COLOUR CAN BE PRINTED ON GRIP.  
FREE SETUP FOR ORDERS OVER 150 GRIPS, OTHERWISE SET UP COST IS £40.



**DTX**



The DTX is our first collaboration with Hank Haney. A combination of contrasting textures, the DTX delivers a great simulation of a cord feel, but adds our seamless molding and rubber technology. Its unique combination of rough and tacky texture is great for any golfer looking for a secure connection with the club, including cord players.



DTX  
Standard: GRPUDS  
Midsize: GRPUDM

BK	WH	GY	RD	OR	GN	BL
BK	WH	GY	RD	OR	GN	BL

Neon Colours:  
PK

**Pro**



Featuring a firm grip with a uniform traction groove surface, the Pure Pro grip is great for experienced players who prefer a rougher feel, maximum feedback and alternative to cord grips.



Pro  
Undersize: GRPUPU  
Standard: GRPUPS  
Midsize: GRPUM

BK	WH	GY	PK	RD	OR	GN	BL	BB	NB	PU
BK	WH	GY	PK	RD	OR	GN	BL	BB	NB	PU
BK	WH	GY		RD	OR	GN	BL		NB	PU

Neon Colours:  
YW  
YW NO  
YW

**P2 Wrap**

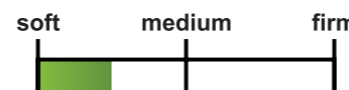

Our tackiest grip, the P2 Wrap features a perforated wrap design and fits golfers with standard size hands that prefer a slightly softer, more muted feel at impact. This grip is great for wet or humid locations and for those that really like a tacky feeling grip that will absorb some vibration.



P2 Wrap  
Standard: GRPUWS  
Midsize: GRPUWM  
Jumbo: GRPUWJ

BK	WH	GY	PK	RD	OR	GN	BL
BK	WH	GY		RD	OR	GN	BL
BK	WH						

**The Big Dog Putter**

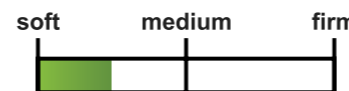

The Big Dog is designed for golfers that prefer an oversized grip with less taper. The subtle taper and modified cylindrical shape increases the size of the grip in the bottom hand, encouraging proper release of the putter head. By using the same proprietary PURE Tack rubber compound found in all our other grips, The Big Dog is extremely durable and actually a little heavier than other grips of its size currently in the market. Weighing in at about 120 grams, The Big Dog puts some weight in your hands and delivers a counter balance effect that increases the stability of the club head throughout the putting stroke.



Putter  
Classic: GRPPUC  
Midsize: GRPPUM  
BigDog: GRPPUB

BK	WH	GY	PK	RD	OR	GN	BL
BK	WH	GY	PK	RD	OR	GN	BL
BK	WH	GY	PK	RD	OR	GN	BL

# FREE COMPRESSOR DEALER OFFER



**BUY £550**  
**PURE GRIPS & GET A FREE**  
**SILENT COMPRESSOR**

\* Can include logo grips & compressor accessories



## Pure Grips Accessories

### Low Noise Silent Air Compressor

New 2018

#### ASSCOMPS

Lightweight and portable for great manoeuvrability. Suitable for inflating, short spraying and blowing. Supplied with 4 x rubber feet. This compressor has been selected because of its silent operation. In a shop environment its important to keep the noise down.

- 1.5hp Motor
- 180Ltr/min Free Air Displacement
- Max. Pressure 8bar
- Oil-Free Lubrication
- Quick-Release Air Line Coupling
- 5m Air Hose Included
- Tank Pressure Manometer



### Pure Grips Air Gun

#### ASSPUGG



### Grip Gun Adaptor

#### ASSPUGGA



### Golf Mechanix Auto Grip Vice

#### ASSGMGV



### Build Up Tape

#### ASSPUBT



### Air Gun Hose

#### ASSPUGGH



### Pure Grips POS Display Stand

#### GRPUPOS



### Pure Grips Grip Display Stand

#### STANDPURE



\*Stand may vary

### Pure Grips POS Banner

#### GRPUBAN

- 39" w x 22" h.



## Crossline

With a distinctive, densely spaced pattern that promotes light grip tension and superior lateral traction, Lamkin's proprietary rubber compound adds tackiness and durability, while the grip's firmness is appealing to a broad range of golfers.



Standard: GRMLCL Midsize: GRMLCLMS Oversize: GRMLCLJ Ladies: GRMLLCL

## Crossline Paddle Putter

One of the most preferred putter grips on Tour, the combination of the unique paddle shape and Crossline surface pattern give the Crossline Paddle its distinctive look and medium-firm, tacky feel.



Standard: GRPLCLPB

## R.E.L. Ace®

The R.E.L. ACE 3GEN grip. Engineered with the super tacky advanced cohesive elastomer, providing a confident connection with the ideal light-pressure grip and dampening of shot feedback, whilst the texture maximizes surface contact with a player's hands. Ideal for a broad range of players looking for a comfortable and versatile golf grip.



Ladies/Undersize: GRLLREL NP PU

## Arthritic Grip

A unique 'nubbed' texture and larger profile, the Lamkin Arthritic Grip promotes lighter grip pressure, allowing players with limited hand and arm strength to comfortably and confidently grip their clubs.



Midsize: GRMLAG

## Jumbo Putter

Extra-large putter grip that minimizes hand pressure and eases forearm stress, allowing for an extra-smooth putting stroke.



Oversize: GRPLJ

## 2016 Sink Putter Grips

A super lightweight rubber for a more responsive feel, the SINK putter grips feature a pronounced curved-handle profile to promote proper wrist alignment for a more fluid and consistent putting stroke.



Squared 13 Putter: GRPLSS13 OY



Rounded 13 Putter: GRPLSR13 GB



## Sink Putter Grips

A super lightweight rubber for a more responsive feel.

GRIPS & WORKSHOP



## FIVE ZONE HIGH-PERFORMANCE ENGINEERING ONE PERFECT GOLF GRIP

### ZONES 4 & 5

A shallow micro-texture provides a smoother and more comfortable feel in the non-glove hand, while the V-shaped dividing groove promotes a consistent and proper grip position of a golfer's lower hand.

### ZONES 1 & 2

The intricate horizontal pattern includes a soft cord weave that delivers exceptional traction in the upper hand, enhanced comfort and slip-free grip confidence in all weather conditions.

### ZONE 3

The critical middle zone of Z5 includes two FingerLock panels that secure a golfer's thumb in a consistent grip position with every swing. The simulated rope texture offers a unique tactile response that reinforces club control without excessive grip pressure.

The most technically advanced and responsive part of your game, your hands, finally has a grip to match. The new Z5 features five distinctive grip zones scientifically engineered to promote proper hand placement and the ideal light-pressure grip with every swing. The Z5 multi-compound foundation is combined with a functional network of textures and patterns to deliver a new level of comfort, control and consistency.



Standard: GRMLZ5 **BK** **BL** **RD**

Midsize: GRMLZ5M **BK** **BL** **RD**

## Two Thumb Pistol Putter Grips

110 grams - A mid sized grip with our new unique dual grip texture hi tac feel.



GRP2TDS **■**



Midsize: GRP2TDR **■**

## Longridge Putter Grip

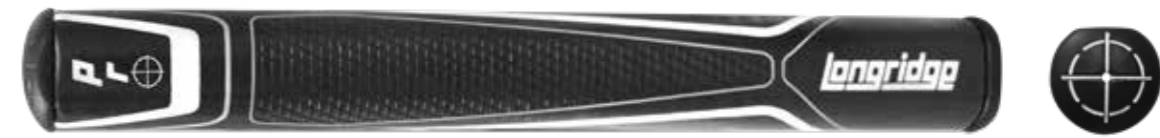

Longridge Pro Grip 2.0: GRMPG2 **New 2018**

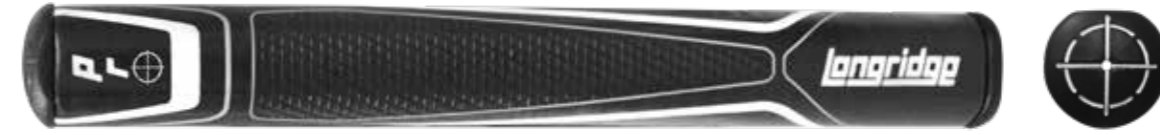

Longridge Pro Grip 3.0: GRMPG3 **New 2018**



Longridge Superlite Oversize Grip: GRPSPG **New 2018**



Black Tour Grip: GRMCL



Grand Tour Oversize Grip: GRMOSGT



Velvet Putter Grip: GRPVE



Junior Tour Wrap Grip: GRJTW



Junior Putter Grip: GRJPU

## Longridge Training Grips



Standard: GRMTG Junior: GRJTG



LONGRIDGE VELVET  
Unique tacky pattern  
all rubber grip  
Core Size: 60 Round  
Weight: 60g Std



### Golf Pride Slat Wall Grip Stand

STANDGRIDE STANDGWALL

Holds 8 golf grips



Contains: 2x golf grips stands, 4x golf grips trays, Golf Pride banner.



### Pure Grips POS Display Stand

GRPUPOS  
● 39" w x 22" h.



### Voice Caddie Display Unit

GAGPSVCPOS  
● Ideal for displaying Voice Caddie products.  
● Lockable with 2 keys.  
● Storage compartment.



### SC200 Dummy Unit

GAGPSSC2DUM



### Voice Caddie SC200 POS

GAGPSSC2POS



### Pure Grips Grip Display Stand

STANDPURE



### Slat Wall Golf Grip Display Stand

GRSSSPOS

Holds 10 golf grips



### 4pk Golf Grip Slat Wall Display Trays

GRSSPOST  
4pk golf grip slat wall display trays with branding for Golf Pride, Lamkin, Super Stroke and Winn Grips.



### Wooden Pitchfork Stand

STANWPITCHFOR

● Wooden stand to display ball markers and 56 pitchforks.



### Perspex Pitchfork Stand

GAAPFBMD

● Perspex counter top pitchfork and ball marker display stand.



### Bettinardi 12 Putter Display Stand

BPPOS12

● 35" x 15" x 34"  
● Weight: 28lbs



### BETTINARDI BANNERS

BPBANUS - USA Banner  
BPBANEU - Europe banner  
BPBANCO - Corporate banner  
BPBANCO1 - Corporate banner

BPBANSS - Studio Stock  
BPBANQB - Queen Bee  
BPBANBB - BB Series  
BPBANWE - Wedges



● PVC 90x60cm  
● Rings in every corner

### Enerator Floor Standing FSDU

SAEN64FSDU  
64pk FSDU

● Holds a maximum of 64 packs of various sizes.



### Welling Putt Standard POS

PAPMWPOS

● 170x76 / 67"x 30"  
● Contents include:  
18 x WellPutt Mat  
18 x Arc to Arc  
5 x Wellstance  
5 x Arc Weights.  
● Full HD TV with dynamic product presentation (movie)



### Welling Putt Display Stand

PAPMWSPOS

● 110x50x45cm / 43"x20"x18"  
● Contents include:  
4 x WellPutt Mat  
9 x Arc to Arc  
6 x Wellstance  
6 x Arc Weights.



### Champ S6 36pk Spike Display Stand

SACHS6

● 13" w x 9" d x 14.25" h.



### Champ Tee Display Stand

SACHT12



### I Gotcha Counter Display Unit

● Holds 18 I Gotcha Compact Ball Retrievers.



### Clicgear 3.5+ POS

TRCCAPOS35



### Rovic RV1S POS

TRCCAPOSRV1S



## Golf Club Shafts

### True Temper

- Steel wood shaft.
- Parallel tip.



### True Temper: Dynamic Gold

- High-flex, tour weight shaft.
- Step pattern for exceptional performance.



### Players

- Ultra light graphite.
- Black shaft for irons.
- Black shaft for woods.



### Longridge

- Uniflex steel wood shaft.
- Parallel tip.
- Stepped steel finish.



### Pro Custom

- Ultra light graphite.
- Trip to flex requirements.



### Stimp Meter

#### CESM

- Aluminium construction.
- Measures speed of greens.
- Length: 93cm.



### Grip Tape

50mm x 300mm  
Wide Strip 10pk  
ASGT5010



## Ball Packaging

- Clamshell for 6 balls 2 x3: XCLLB6
- Clamshell for 12 balls 4 x3: XCLLB12
- PVC drawstring bag for 18 balls: XBALB18
- Mini golf bag for 30 balls & 20 tees: XLBA30



## Packaging Boxes

- 130cm x 19cm x 10cm Irons/woods box: XBOXWOOD
- 36cm x 30cm x 101cm Fits golf bag: XBOXBAG



## Universal Shaft Extension

#### ASSEU

- Extends shaft up to 5cm.
- Suitable for steel graphite, for both mens & ladies.



## Rapid Epoxy Glue Syringe Rapid Epoxy Glue Tube

#### ASER15

- Dries in 4 Minutes.
- High Strength Bond.



#### ASER15T

- Dries in 4 Minutes.
- High Strength Bond.



Custom Logo 

Customise your game with a complete range of Golf accessories, gift and Bags with our high quality embroidered, laminated or 3D domed decal.

## Custom Logo Pitchforks

### Eze Auto Pitchfork

- Decal: 25mm.
- Length: 11cm.
- Weight: 30g.



### Promo Silver Pitchfork

- GAPMESLO**
- Decal: 22mm.
  - Length: 7.5cm.
  - Weight: 32g.



### Apex Pitchfork

- GAPFARSLO**
- Decal: 22mm.
  - Length: 9cm.
  - Weight: 26g.



### Laurel Pitchfork & Clip

- GAPMCSLO**
- Decal: 21mm.
  - Length: 7.5cm.
  - Weight: 42g.



### Vector Pitchfork

- GAPFBLO**
- Decal: 18.5mm.
  - Length: 9.5cm.
  - Weight: 22g.



### Pitchfork & Bottle Opener

- GAPFBBLO**
- Decal: 24mm.
  - Length: 8cm.
  - Weight: 26g.



## Plastic Pitchfork

- GAPMPWLO**
- White
  - One colour printing or dome decal



**GAAPFBMD**

**STANWPITCHFOR**

**OFFER**

ORDER 100  
GET A FREE PERSPEX STAND

ORDER 200  
GET A FREE WOODEN STAND

## Pitchmaster

- ASBGAPMLO**
- Award winning stainless steel pitch repair tool.
  - Magnetic ball marker.
  - Available patriot, novelty or custom logo.



## Logo's are available as high quality laminated or 3D domed decal



- High Quality Heavy Duty Laminated Decal**
- Full colour print.
  - Waterproof.
  - Durable.
  - Easy to clean.
  - Professional tough finish.

- 3D Domed Decal**
- Clear polyurethane doming
  - Full colour print
  - Waterproof
  - Durable
  - Easy to clean
  - Professional tough finish



## Custom Ball Markers

### Cap Clip & Ball Marker

- GACCP5LO**
- Decal size 23.5mm.



### Deluxe Cap Clip & Ball Marker

- GACCSLO** Silver    **GACCLO** Bronze
- Decal size 23.5mm.



### Blank Metal Ball Marker

- GABMSF5LO** Flat  
**GABMSS5LO** Studed
- Decal size 21.5mm.



**Metallic Finish Now Available At extra cost of +20%**

## Poker Chip Ball Markers

### Premium Poker Chips with Laminated Decal



- **GABMPO2BLLO** Blue/White
- **GABMPO2GRLO** Green/White
- **GABMPO2RDLO** Red/White
- **GABMPO2BKLO** Black/White

- Extra Large: 31mm logo.
- Logo on both sides.
- Quality hard wearing laminated decal.
- Different logos can be printed front and back.
- Premium quality chip.

### Standard Poker Chips with 3D Domed Logo



- **GABMPOBLLO** Blue/White
- **GABMPOGRLO** Green/White
- **GABMPORDLO** Red/White
- **GABMPOBKLO** Black/White
- **GABMPOWHLO** White/Blue

- Single sided.
- High quality 3D domed decal: 24mm.



**Buy 100pcs And Get A Free Counter Display Unit**

### Poker Chip With Removable Magnetic Ball Marker

- 2 ball markers in 1.
- Larger poker chip marker with small magnetic ball marker.
- Decal size: 22.5mm.

- **GABMOMBKLO** Black/White
- **GABMOMRDLO** Red/White
- **GABMOMBLO** Blue/White



AVERAGE LEAD TIME 2-4 WEEKS ON ALL LOGO PRODUCTS SET-UP COSTS MAY APPLY

## Custom Tees Printing

### Tee Deal TEEDEAL

- Choice of 53 & 69mm Tees.
- Bagged in 20's or Loose 1000.
- Lead time: 6-8 Weeks.
- Price £24.99 Per 1000.
- Min order qty 10,000 Tees.
- Tee colour can be chosen.
- 1 colour logo only.
- Printing on cup can also be supplied, ask for details.



## White Wooden Tees

### Tee Deal TE1WO53WLO 53mm TE1WO69WLO 69mm

- 53mm or 69mm High Quality White Wooden Tees available for custom logo in 1 colour on the shank
- Min order 1,000 and further units of 1,000 e.g.: 2,000, 4,000...
- Can be packed in bags of 1,000 loose or in bags of 20, 50, 100 etc for an extra charge
- Lead time is approx. 2 - 3 weeks from confirmed artwork/order



## CHOOSE FROM STANDARD COLOURS OR SPECIFY A PANTONE COLOUR



## Three Fold Luxury Towel

- 40cm x 50cm unfolded.
- 100% Cotton.
- 3 fold with grommet & hook.
- Delivery time: 6 weeks.
- Min quantity 6 pcs

- **CAGT3LRDLO** Red
- **CAGT3LBLLO** Blue
- **CAGT3PLO** Pink
- **CAGT3LGNLO** Green
- **CAGT3LBKLO** Black

### Towel colour in stock

### TOWEL DEAL

- Choice of 18 colours.
- Lead time: 3-4 Weeks.
- Price £4.50 minimum 100 pcs.
- Towels colour can be mixed if stock available.
- Free set up.



## Custom 2 Piece Golf Ball

- Suitable for logo/promotion.



BL2PBLO  
White

## Luxury Two Fold Towel

### CAGT2BLO Black

- Mesh pocket for balls and tees.
- Measures 19 x 59cm folded.
- Embroidered logo.
- Set up: £35



Pocket for balls, tees & accessories

## Economy Three Fold Towel

### CAGT3BLO Black CAGT3PKO Pink

- 45cm x 7.8cm folded.
- 3 fold towel with bag hook.
- Set up: £35



## Custom Pencil & Eraser

### GAPELO

- 99mm long.
- Logo area: 50mm x 16mm.
- Available in colours: black, white, blue, yellow, natural & red.
- 1 colour logo or full colour for white version.
- Also available without eraser.



FULL COLOUR LOGO ON WHITE NOW AVAILABLE

New 2018

## GroovTec Multi-pin Club Cleaner

### CAGTLWLO

- Decal size: 23mm.
- Multi-pin groove cleaner & ball marker.



## Groove Brush Pro

### CAGBPLO

- Printed 20mm diameter decal.
- Bag clip.



## Pocket Ball Washer & Ball Marker

### CAPBWLO

- Putt clean each time.
- Clean your golf ball on the green without a towel.
- Includes logo magnetic ball marker.
- Dome Size: 24mm.



## Personalised 2 Piece Range / Practice Balls

- Personalising range balls or range ball stripe.
- Available 1pc or 2pc.
- 85 compression, 330 dimples.
- Timescale 3-4 weeks.



BLRERB2WLO  
White

BLRERB2YLO  
Yellow

## Golfer's Wash Bag

### GGWSBLO

- Perfect gift for any golfer.
- Includes:
  - 2 internal mesh pockets,
  - 2 external zip pockets,
  - carry handle.
- Diamond Dome Size: 45w x 25h mm.



## Golfer's Shoe Bag

### GGSBLO

- Large size comfortably fits shoes & accessories.
- Includes luggage tag.
- Diamond Dome Size: 60w x 30h mm.



## Executive Mesh Shoe Bag

### SASBELO

- Breathable mesh panel.
- Large zipped compartment.
- Top easy carry handle.
- Protects shoes.
- Oval Dome Size: 43 x 63mm.



## Executive Shoe Shine Kit

### GGSKLO

- Neutral & Black Polish.
- Hard & Soft Brushes.
- Buffing Cloth.
- Diamond Dome Size: 60w x 30h mm.



## Mesh Shoe Bag

### SASBMBLO

- Mesh ventilation to aid drying.
- 40mm x 25mm Domed logo.
- Includes dual zip and carry strap.



## Deluxe Scorecard Holder

### GASCDLO

- Luxury lining with pocket.
- Includes pencil holder.
- 40mm x 25mm domed logo.
- Bespoke dome size is also available.
- Available in colours: Blue, Pink, Red, Black.



## Executive Scorecard Holder

### GASCLELO

- Keeps scorecard secure.
- Durable synthetic leather cover.
- Size: 145mm x 195mm.
- Includes magnetic ball marker.
- Includes pencil holder, (pencil not included).
- Dome Size: 24mm.



## Custom Logo Golf Bags

Selected cart and stand bags have detachable pocket panels that can be easily embroidered with your logo. Below is how easy it is to get your logo on your bag.



### STEP 1.

Remove detachable pocket panel.



### STEP 2.

Post the panel to us with your order form and email us your logo artwork.



### STEP 3.

We embroider your logo.



### STEP 4.

We return your panel back to you.



### STEP 5.

Attach your panel back onto your bag.

### LOGO EMBROIDERY PRICING:

Logo: £5 per bag: Set up charge £35

TEXT: £5 per bag: No set up charge.

Note: Logos must be sent in one of the following formats: High resolution jpeg, tif, eps, pdf or Illustrator.ai file. Pantone colours must be specified. Text/Fonts must be outlined or font style supplied.

## Customisable Bag Range

The following cart and stand bags have detachable pocket panels that can be embroidered with your logo. Location of detachable pocket is marked with 1. All colours in that range can also be customised.



BATCRDN  
Black/Navy



BA5P  
Black/Navy

BA5PBS  
Black/Silver



BBCBC500BC  
Black/Charcoal

BBCBC500BL  
Black/Charcoal/Lime

BBCBC500BRB  
Black/Royal/Silver

BBCBC500BR  
Black/White/Red

## 60" Dual Canopy Umbrella

### UMWPP30LO

- Umbrella Print Details:
- Printing on coloured panels max print area 25cm x 10cm.
- Printing on white panels - maximum print area 30 x 20cm.
- Minimum order of 12.
- Average lead times 2-4 weeks (unless otherwise stated).
- £25 Set-up cost.
- Printing on coloured panels will occur extra cost.

\* BagBoy Umbrellas custom logo also available



UMWPP30BWLO  
Black/White



UMWPP30NLO  
Navy



UMWPP30BLO  
Black



UMWPP30RBWLO  
Blue/White



UMWPP30NWLO  
Navy/White

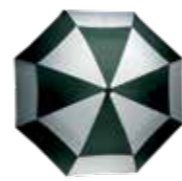

UMWPP30GWLO  
Green/White

## All Weather Glove

### GLAWLO

- Magnetic ball marker with logo.
- Lycra knuckles & fingers.
- Available in black & white.
- Dome Size: 24mm.



## Eco Vessel Custom Bottles

UP TO  
100  
HOURS  
COLD

UP TO  
24  
HOURS  
HOT

TriMax  
INSULATED

18/8  
STAINLESS  
STEEL

BPA FREE

100  
YEAR  
WARRANTY

## Laser Engraving

- Order minimum 12 pcs per style



- Laser engraving

## Screen Printing

- Order MOQ - 24 units per logo and print type
- Style MOQ - 24 units per bottle style
- Color MOQ - 12 units per bottle color



- One colour Screen print

- Two colours Screen print

AVERAGE LEAD TIME 2-4 WEEKS ON ALL LOGO PRODUCTS SET-UP COSTS MAY APPLY

# Golfkontor

All you need!



**Golf Pride**



**COLIN MONTGOMERIE**



**ENERTOR**

POWERED BY D3O



**rovic**  
clickgear



**voice caddie**

